

# Contents

## THE BASICS

---

Introduction.....	1
Front Panel.....	2
Back Panel.....	3
Connecting to a Computer.....	5
Basic Operation.....	5
How to Use the Menu System.....	6

## THE BUTTONS

---

The Buttons.....	8
Mode Button.....	8
MSG1-MSG4 Buttons.....	8
Button Combinations.....	8
Decrement.....	8
Increment.....	8
Repeat Reader Buffer.....	8
Freeze Reader Buffer.....	9
Pulse Tune.....	9
Carrier Tune.....	9

## THE MENUS

---

Main Menu.....	10
Speed.....	10
Weight.....	10
Tone.....	10
Reader Speed.....	10
Setup Menu.....	10
Overall Speed.....	11
Farnsworth.....	11
Weight.....	11
Character Space.....	12
Word Space.....	12
Keying Compensation.....	12
Keying Delay.....	12
PTT Hang Time.....	12
Tone.....	13
Serial Number.....	14
Leading Zeroes.....	14

Other Zeroes .....	14
Nines .....	14
Iambic.....	14
Reverse.....	15
Paddle.....	15
Monitor.....	15
Output.....	15
Queue .....	15

**THE READER**

---

Using the MFJ-464 Reader .....	16
Operation.....	16

**THE PADDLE**

---

Using the MFJ-464 with a Paddle .....	17
Setup Commands.....	17
Message Memory .....	18

**THE KEYBOARD**

---

Using the MFJ-464 with a Keyboard .....	19
Quick Mode.....	19
Keyboard Layout .....	19
Repeat.....	19
Caps Lock.....	19
Keyboard Operation .....	19
Keyboard Key Combinations.....	21
Setup Commands.....	22
Message Memory .....	27
Quick Speeds.....	27

**THE TERMINAL**

---

Using the MFJ-464 with a Terminal Program .....	28
Setup Commands.....	28
Message Memory .....	33
Uploading and Downloading Messages .....	33
Loading a Memory Block from the Computer .....	34
Sending Contents of a Memory Block to the Computer.....	34

---

**THE MEMORY**

---

Message Memory .....	35
Preparing Messages .....	35
Embedded Commands .....	36

---

**APPENDICES**

---

Resetting the Keyer .....	39
Factory Defaults.....	39
Message Memory Reset .....	40
Self Test .....	40
Failure Message Meanings .....	41
Power Down Circuit Test .....	41
Jumper Settings .....	42
Troubleshooting .....	42
Technical Assistance .....	42
Morse Code Character Set .....	43
Signals Used in Other Radio Services.....	44
Some CW Abbreviations .....	44
Meaning of Q Signals .....	45
Setup Commands.....	46
Schematic.....	47

---

**FIGURES**

---

Figure 1: MFJ-464 Front Panel .....	2
Figure 2: MFJ-464 Back Panel .....	3
Figure 3: Qwerty Keyboard Layout .....	4
Figure 4: Dvorak Keyboard Layout .....	5
Figure 5: MFJ-464 Flow Chart and Button Action Chart.....	7
Figure 6: Code Weight.....	11
Figure 7: Keying Delay and PTT Hang Time Timing .....	13
Figure 8: Rise Time and Decay Time Timing .....	13
Figure 9: MFJ-464 Message Memory Structure .....	35



# The Basics

## Introduction

The MFJ-464 KeyReader is a full-featured memory keyer combining dual microprocessors and a non-volatile EEPROM chip for a full featured, low cost, high reliability design. Unlike other keyers, it uses a LCD display to set keyer functions and show the sending message. The MFJ-464 keys CW from a paddle, a keyboard and a serial computer interface. All code parameters are changed with an easy to use menu interface shown on the LCD display. The MFJ-464 has four message memories of over 220 characters each which can be loaded by paddle, keyboard or from a computer with a terminal program. The MFJ-464 can repeat messages continuously, insert timed pauses within messages, insert an auto-incrementing serial number, have messages call other messages or insert embedded commands into a message. Commands also can be simply sent to the keyer in Morse code using your paddles, keyboard, terminal program on your computer, or push-button switches on the unit.

The MFJ-464 has controls for volume and speed on the front of the unit. The paddle jack connects to any iambic or single lever (dual contact) key paddle. The keyboard port allows use of an optional keyboard for keyboard keying operation. The serial interface allows connection of most RS-232 compatible computers. Some of its features:

- 2-line by 16-character LCD display.
- Iambic keyer with dot and dash memories; automatic, semi-automatic or hand-key mode.
- Four messages of over 220 characters each.
- Messages may “call” other messages and contain programmed functions.
- Input queue to store multiple message activation.
- Auto-incrementing contest serial number from 001 to 9999.
- Adjustable code speed from 5 to 99 WPM.
- Farnsworth mode with speed from 10 to 99 WPM.
- Ultra speed mode allows messages at speeds up to 990 WPM.
- Adjustable weight on code elements from 25% to 75%.
- Adjustable sidetone frequency from 300 to 1000 Hz.
- Compensation for transmitter character shortening up to 25 ms.
- Keying output delay up to 20 ms to accommodate switching delay.
- Push-to-talk (PTT) hang time up to 10 seconds.
- Direct (positive) keying.
- Carrier tune and adjustable pulse tune functions for transmitter adjustment.
- Timed pauses within messages and message loop capability for continuous replay.
- Message and keyer configuration saved without battery backup.
- Internal sidetone speaker with adjustable volume.
- Support for Qwerty and Dvorak keyboards with RepeatKey feature.
- 190 characters type-ahead keyboard buffer with buffer-full warning.
- Reader decodes Morse code up to 99 WPM with automatic speed tracking.
- Reader repeat buffer of 80 characters.

## Front Panel

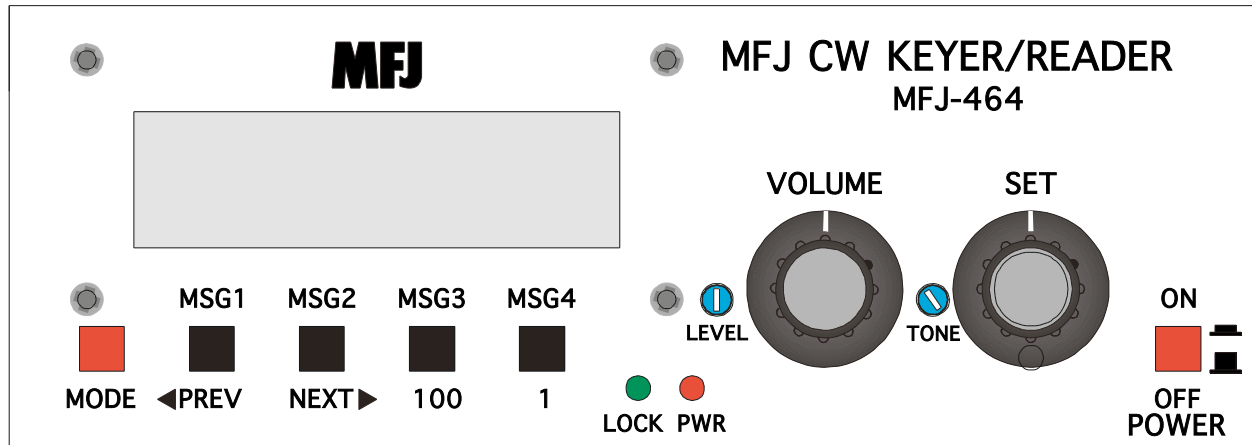

Figure 1: MFJ-464 Front Panel.

- **LCD Display:** A 2-line by 16-character alphanumeric display. It displays the keyer's various menus and the code being sent and received. Normally, the top line shows the transmitted characters and the bottom line shows the received characters. The bottom line can be toggle to show the keyboard type-ahead buffer.
- **Mode Button:** The Mode button is time-sensitive and uses to navigate through the various menus and to enter or exit the setup menus.
- **Message Buttons:** The Message buttons MSG1 to MSG4 are used to program and playback the four message memories. They also use to navigate through the setup menus. These buttons are time-sensitive.
- **Lock LED:** The Lock LED blinks in sync with the incoming Morse code message.
- **PWR LED:** The PWR LED illuminates when the power to the unit is on. It also blinks when the keyer is in message program mode and command mode.
- **Level Control:** The Level control adjusts the input level.
- **Volume Control:** The Volume control adjusts the sidetone audio volume to the internal speaker and Audio Out jack. Turn the control clockwise to increase the volume and counter-clockwise to decrease the volume.
- **Tone Control:** The Tone control adjusts the tone frequency. It is factory set to 700 Hz.
- **Set Dial Control:** The Set dial control adjusts the keyer setting for the active mode. Turn the control clockwise to increase setting and counter-clockwise to decrease setting.
- **Power Button:** The Power button turns the unit on and off. Press to turn power on; press again to turn power off.

**WARNING:** Do not turn the power on and off rapidly, otherwise the memory (keyer settings) would be corrupted and the unit will have to reset to factory defaults to function properly.

## Back Panel

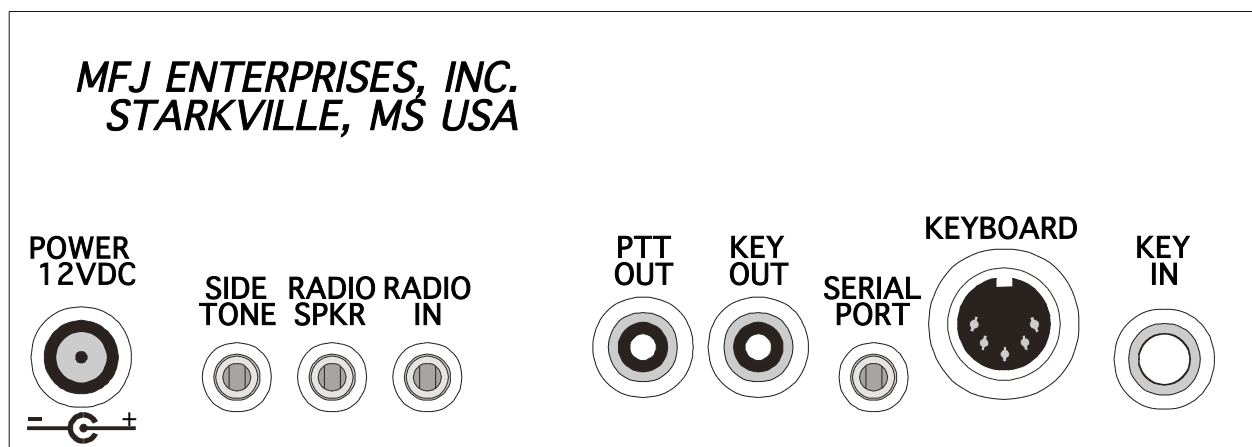

Figure 2: MFJ-464 Back Panel.

- Power:** The Power jack accepts a 2.1 mm coaxial plug with positive center and negative sleeve. This unit requires 12 volts DC. An optional 500 mA power supply, the MFJ-1315, is available from MFJ Enterprises, Inc. This unit requires a minimum of 50 mA at no volume and without using a keyboard and a maximum of 300 mA at maximum volume into an 8-ohm audio load with a typical keyboard. It may require more current depending on the keyboard used; typical keyboard uses about 100 mA.

**WARNING:** Do not apply voltages greater than 18 volts to this unit, or permanent damage to the unit may result.

- Side Tone:** The Side Tone is a 3.5 mm stereo phone jack for connecting to an external speaker or headphones. This jack accepts both stereo and mono plugs. When this jack is used, the internal speaker is disabled. An optional external speaker, the MFJ-281, is available from MFJ Enterprises, Inc.

**WARNING:** To prevent suffering hearing damage when using headphones, turn the Volume control to minimum before putting on the headphones and then slowly adjust for a comfortable volume.

- **Radio Spkr:** The Radio Spkr is a 3.5 mm stereo phone jack for connecting to an external speaker. This jack is normally a bypass of the Radio In jack. This jack accepts both stereo and mono plugs.
- **Radio In:** The Radio In is a 3.5 mm stereo phone jack for connecting to the radio's headphones or line out. This jack accepts both stereo and mono plugs, but only the tip of the plug is used.
- **PTT Output:** The PTT Output is an RCA jack providing connection for a PTT (push-to-talk) output that goes low when active. This jack is an open-drain output; an external pull-up can be used if so desired. Use a quality-shielded cable for connection to this jack.
- **Keying Output:** This unit supports *only* positive keyed radios (most solid-state radios). Use a quality-shielded cable for connection to this RCA jack. Consult your transmitter's manual to determine if it uses direct (positive) or grid-block (negative) keying. If your radio is negative keyed, the transmitter will either not key at all or key continuously.
- **Serial Port:** The serial port on the back of the unit accepts a 3.5 mm stereo phone plug to a standard 9-pin female plug for connecting the MFJ-464 to a computer for ASCII file transfers or monitoring your sending on the computer screen. A 3.5 mm to DB9 serial cable, the MFJ-5161, is available from MFJ Enterprises, Inc. If your computer has a 25-pin serial port, use a 9-pin-to-25-pin adapter. If you prefer you can make this cable using the following table:

Connect 3.5 mm Stereo Plug	To DB9 (female)	To DB25 (female)
Tip (TxD)	Pin 2	Pin 3
Ring (RxD)	Pin 3	Pin 2
Sleeve (GND)	Pin 5	Pin 7

To communicate with the MFJ-464, use a terminal program on your computer that is capable of transferring information in ASCII format. Configure the software for 9600 baud, 8 data bits, 1 stop bit and no parity; set the flow control to Xon/Xoff.

- **Keyboard:** The keyboard port accepts most standard AT style keyboards (XT keyboard does not work with the MFJ-464). The MFJ-551 keyboard is guaranteed to be fully compatible with the keyer and available from MFJ Enterprises, Inc.

Configuration of the keyboard operation is set in the Quick mode (see page 19). It allows selection of whether a Qwerty or Dvorak keyboard is used (see Figures 3 and 4). The Repeat feature selects whether or not to repeat a key when it is held down. The Caps Lock power on status can also be selected. The factory defaults are Qwerty keyboard, Repeat off and Caps Lock on.

- **Key Input:** The Key Input jack is a  $\frac{1}{8}$ -inch stereo phone jack. An iambic or single lever (dual contact) paddle with a shielded cable should be used. When used with paddles, the dot wire should be connected to the tip of the plug, the dash wire to the ring, and the ground wire to the shield.



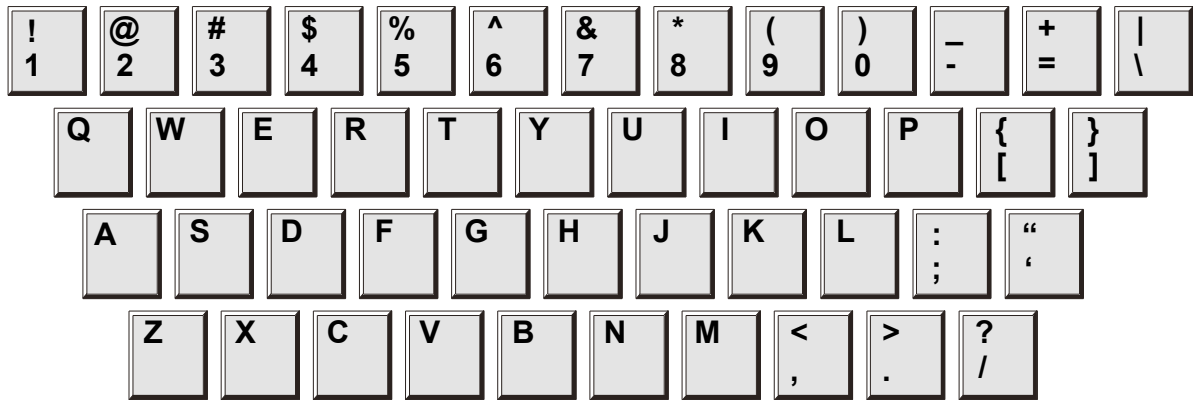

Figure 3: Qwerty Keyboard Layout.

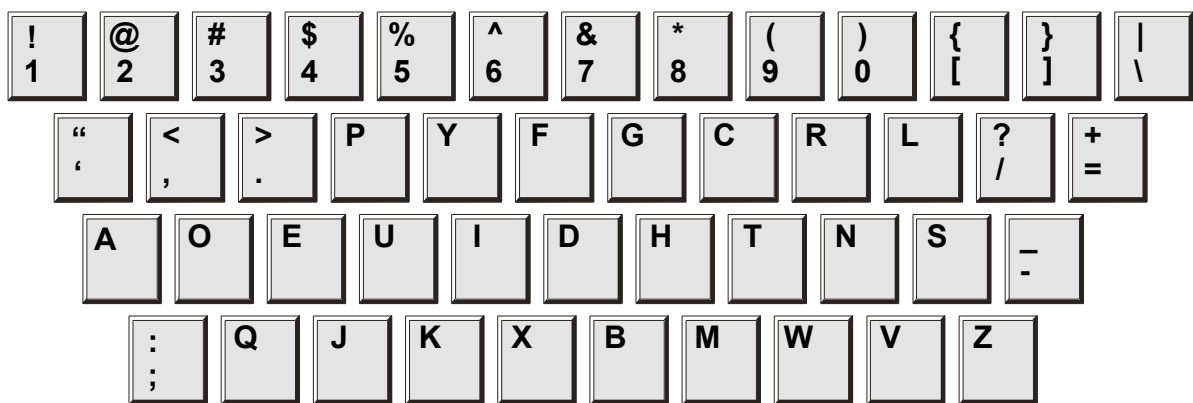

Figure 4: Dvorak Keyboard Layout.

### Connecting to a Computer

You may connect the MFJ-464 to a computer using the 9-pin DIN serial port on the back panel. If your computer has a 25-pin serial port, you can use a 25-pin-to-9-pin adapter.

To use a computer with the MFJ-464, run a terminal program that will upload and download ASCII files, and configure the terminal program to do so. Set the terminal program for 9600 baud, 8 data bits, one stop bit and no parity; set the flow control to Xon/Xoff. If you see extraneous linefeeds on the computer screen when receiving data from the MFJ-464, you may configure your software to strip out these extra linefeeds.

During sending, the characters sent by the MFJ-464 are sent through the serial port, so you may use your computer to monitor the transmitted copy. You may find this particularly convenient.

You also may upload and download text files between the MFJ-464 and your computer. For details on this, see the discussion of “Uploading and Downloading Messages” on page 33.

## Basic Operation

The MFJ-464 is simple to operate. The Power button controls power to the unit. Start sending with a paddle or keyboard. Adjust the volume and speed to your preference. If the speed is still too fast or too slow, adjust the speed using the Set dial control.

All characters or code sent by the user are played on the sidetone speaker. This allows the user to hear what he is keying, typing, or sending with a computer. Only when the keyer is used with a paddle is the code sent as soon as it is keyed. When using a keyboard or keyer terminal, you may type ahead of the code that is being transmitted. This allows you to enter words and phrases faster than the transmitted code. This permits smoother code with less pauses because you can fix misspelled words and think of the right phrase to use while your previous sentence is being sent.

When you are in command mode, memory save, or configuration mode, the code sent to the speaker is not sent to the Keying Output or your radio. This keeps all erroneous code off of the air.

## How to Use the Menu System

You may set up the MFJ-464 to perform any of its many functions by making the appropriate selections from its menu system. This system consists of four main mode menus, 19 setup mode menus and three quick mode menus. You make your selections using the five buttons under the LCD display - Mode, MSG1/Prev, MSG2/Next, MSG3/100 and MSG4/1. These buttons do the following:

- Mode - Scrolls through the main mode menus and setup mode menus when press briefly. To enter the setup mode, press and hold this button for two seconds. To exit the setup mode, press this button to go back to the main mode.
- MSG1/Prev - Play/program message 1 or go to the previous setup menu.
- MSG2/Next - Play/program message 2 or go to the next setup menu.
- MSG3/100 - Play/program message 3 or select step of 100 in setup mode.
- MSG4/1 - Play/program message 4 or select step of 1 in setup mode.

The main mode menus are arranged in a "wrap-around" structure, so that momentarily pressing the Mode button will bring up another main menu in a sequence. Figure 5 shows the sequence of the main mode menus. When power is turned on, the main menu displayed is the one that was displayed when the unit was last turned off.

The setup mode menus are also arranged in a "wrap-around" structure, so that pressing the Previous or Next button will bring up another setup menu in a sequence. Figure 5 shows the sequence of the setup mode menus. When entering the setup mode, the setup menu displayed is the one that was last used.

To see how the setup mode menus system works, consider the following example.

EXAMPLE: To enter the setup mode, press and hold the Mode button for two seconds. If the display shows that you are in the Farnsworth menu, pressing the Next button would put you in the Weight menu and pressing the Previous button would put you in the Overall Speed menu. Adjusting the Set dial control would lower or raise the overall code speed. Once you have selected the speed you desire, you may leave the setup mode by pressing the Mode button again; or press Previous or Next button to go to another setup menu.

Once you have made your choices within the setup mode, they will be saved in non-volatile memory for your next session.

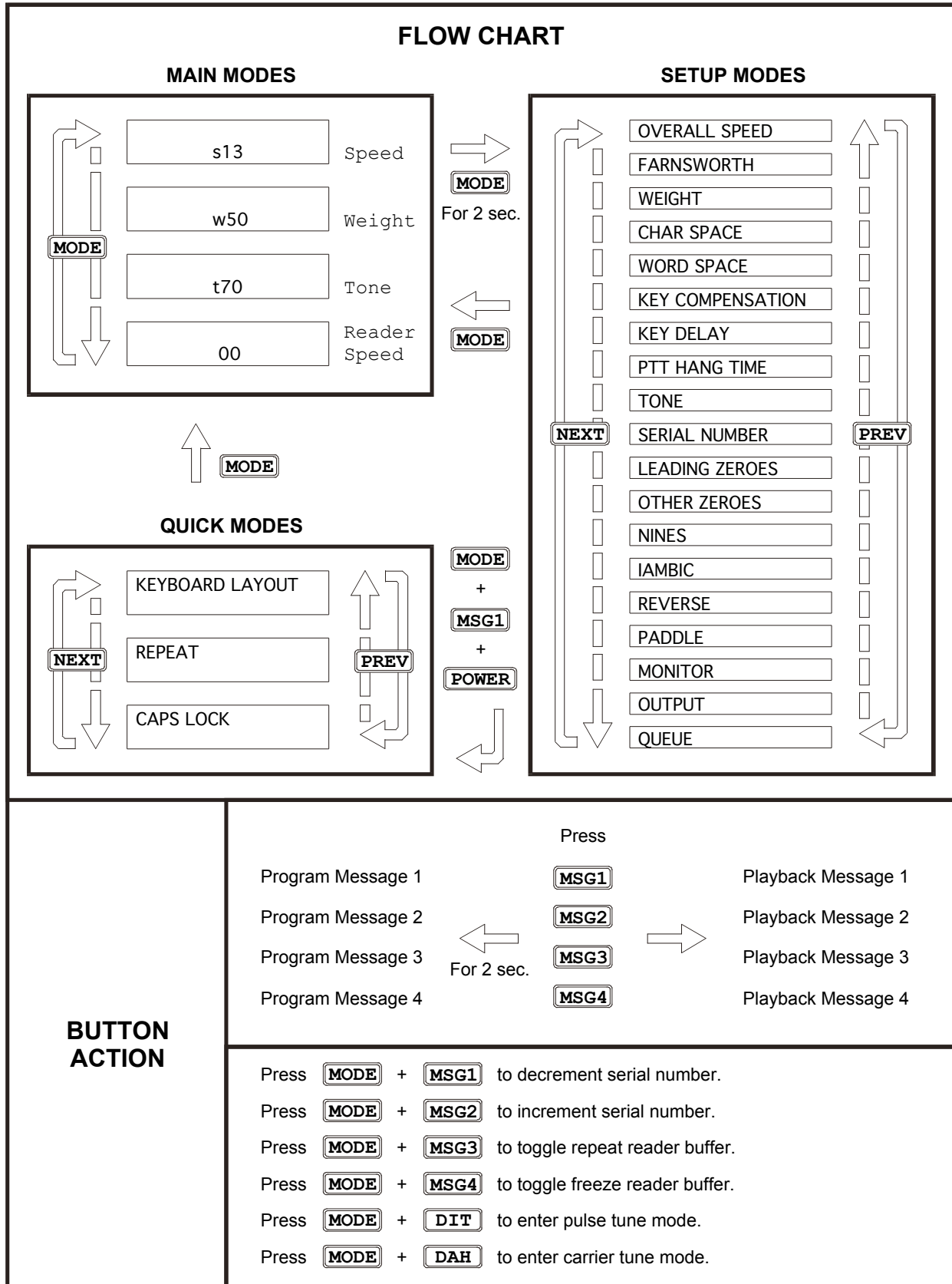

### BUTTON ACTION

	Press	
Program Message 1	<b>MSG1</b>	Playback Message 1
Program Message 2	<b>MSG2</b>	Playback Message 2
Program Message 3	<b>MSG3</b>	Playback Message 3
Program Message 4	<b>MSG4</b>	Playback Message 4

← For 2 sec. →

- Press **MODE** + **MSG1** to decrement serial number.
- Press **MODE** + **MSG2** to increment serial number.
- Press **MODE** + **MSG3** to toggle repeat reader buffer.
- Press **MODE** + **MSG4** to toggle freeze reader buffer.
- Press **MODE** + **DIT** to enter pulse tune mode.
- Press **MODE** + **DAH** to enter carrier tune mode.

Figure 5: MFJ-464 Flow Chart and Button Action Chart.

# The Buttons

## The Buttons

### Mode Button [MODE]

The Mode button is used to change keyer mode. In the main mode, press Mode button to cycle among Speed, Weight, Tone and Reader Speed menus. This button is also used to enter and exit the setup mode, or used in combinations with other buttons and paddles to perform special functions.

### Message Buttons [MSG1] to [MSG4]

There are four messages buttons corresponding to the four messages. To play a message, press and release the corresponding message button. To save a message, press and hold a message button for two seconds until the keyer responds with "GO" (dah-dah-dit dah-dah-dah). You may then key in a message using the paddle, keyboard or terminal. Press any message button to end the message. Refer to "The Memory" section on page 35 for explanation of the MFJ-464's message memory.

## Button Combinations

The Mode button can be pressed in combination with another button or paddle to perform special functions. To do this, press and hold the Mode button, within two seconds press another button or paddle, and then release both buttons and paddle.

### Decrement [MODE] + [MSG1]

Press and hold the Mode button and within two seconds press the MSG1 button to decrement the serial number by one, effectively canceling the automatic increment applied when last played from a message. The decrement function accommodates re-sending the last serial number, as might be needed when a repeat of a contest exchange is requested, or canceling the exchange with a station that proved to be a "dupe". The unit will echo a "D" (dah-di-dit) for every number that is decrement. Decrement serial number 0001 rolls over to 9999, because the number 0000 is not used.

### Increment [MODE] + [MSG2]

Press and hold the Mode button and within two seconds press the MSG2 button to increment the serial number by one. The unit will echo an "I" (di-dit) for every number that is increment. Increment serial number 9999 rolls over to 0001, because the number 0000 is not used.

### Repeat Reader Buffer [MODE] + [MSG3]

Press and hold the Mode button and within two seconds press the MSG3 button to repeat the reader buffer.

**Freeze Reader Buffer [MODE] + [MSG4]**

Press and hold the Mode button and within two seconds press the MSG42 button to freeze the reader buffer.

**Pulse Tune [MODE] + [DIT]**

Press and hold the Mode button and within two seconds tap the Dit paddle to engage the pulse tune mode. The keyer will send a continuous string of pulses to tune your station. The rate (speed of 50 to 99 WPM) and the duty cycle (weight of 1% to 35%) of the pulses can be adjusted with the message buttons. Press MSG1 button to decrease speed and MSG2 button to increase speed. Press MSG3 button to decrease weight and MSG4 button to increase weight. Press Mode button, either paddle or the ESC key to exit.

**Carrier Tune [MODE] + [DAH]**

Press and hold the Mode button and within two seconds tap the Dah paddle to engage the carrier tune mode. The keyer will key continuously to tune your station. Press any button, paddle or key to exit.

# The Menus

## Main Mode Menus

The main mode menus allow you access to the commonly used functions. There are four main mode menus arranged in a “wrap-around” structure. When power on, keyer operation starts with the main menu that was last used. The four main menus give you easier access to the frequently adjusted settings and display their current values. Within each main menu, press the Mode button briefly to view the next main menu. Turn the Set dial control to change the setting of the current menu. Press and hold the Mode button for two seconds to enter the setup mode (see below).

### Speed

This menu is placed in the main menus to allow easier access to change the overall speed in the range of 5 to 99 WPM. When **s##** is displayed, turn the Set dial control to change the overall sending speed. Note that setting the overall speed higher than or equal to the Farnsworth speed will disable Farnsworth spacing.

### Weight

This menu is placed in the main menu to allow easier access to change the weight of code elements in the range of 25% to 75%. Weight is the duty cycle of a continuous string of dots, which is 50% for perfect code. When **w##** is displayed, turn the Set dial control to change the code weight. A higher weight produces a heavier sound, and a lower weight causes characters to sound lighter.

### Tone

This menu is placed in the main menu to allow easier access to change the audio frequency of the sidetone in the range of 305 to 1006 Hz. When **t##** is displayed, turn the Set dial control to change the sidetone frequency. Note the one's digit is not displayed and 1006 Hz is displayed as **t99**. Most people prefer 700 to 800 Hz sidetone.

### Reader Speed

This menu shows the code speed of the incoming Morse code message as **###** WPM. Maximum reader speed that can be displayed is 127 WPM.

## Setup Mode Menus

The setup mode menus allow you to set up how the MFJ-464 works and behaviors. There are 19 setup mode menus arranged in a “wrap-around” structure. To access these setup menus, press and hold the Mode button for two seconds. The setup menu that will display is the one that was last used. When finishing, press the Mode button again to go back to the main mode for normal operation. The LED will blink to indicate that you are in the setup mode. The Keying Output and PTT Output are also disabled.

Within each setup menu:

- Press the Mode button to exit the setup mode and go back to the main mode.
- Press the Next button to view the next setup menu; press the Previous button to view the previous setup menu.
- Press the “100” button to set incremental step to 100; press the “1” button to set incremental step to 1. This affects the Set dial control in the PTT Hang Time and Serial Number setup menus.
- Turn the Set dial control to change the setting for that setup menu.

### Overall Speed

The Overall Speed menu allows you to set the code speed in the range of 5 to 99 words per minute (WPM). By "overall" speed, we mean the speed at which the words are sent. A "word" is defined as 50 units of time, and the word "PARIS" is exactly 50 units in length. Therefore, if "PARIS" is sent 13 times in one minute, the sending speed is 13 WPM. Standard Morse code timing defines a dit as one unit of time and a dah as three units of time. Within each character, there is one unit between elements (dits and dahs). Three units separate characters and seven units separate words. Farnsworth spacing (see below) will increase the amount of time between characters and words. Note that setting the overall speed greater than or equal to the Farnsworth speed will disable Farnsworth spacing.

### Farnsworth

The Farnsworth menu allows you to disable or enable Farnsworth mode and set the Farnsworth speed (character speed) in the range of 10 to 99 WPM. When Farnsworth mode is enabled, characters (dots, dashes, and intra-character spaces) are sent at the Farnsworth speed, but the spacing between characters and words is increased to produce a slower overall speed. This technique is useful for helping the novice learn the sounds of the code characters and avoid the tendency of counting individual dots and dashes. The Farnsworth speed is always higher than the overall speed. As a result, Farnsworth mode (if enabled) is automatically disabled when the overall speed is changed to one that is greater than or equal to the current Farnsworth speed. Also, Farnsworth speed cannot be enabled when the overall speed is at its maximum of 99 WPM.

### Weight

The Weight menu is used to set the code weight in the range of 25% to 75%. Weight is the duty cycle of a continuous string of dots, where 50% for perfect code. A higher weight produces a heavier sound and a lower weight causes characters to sound lighter.

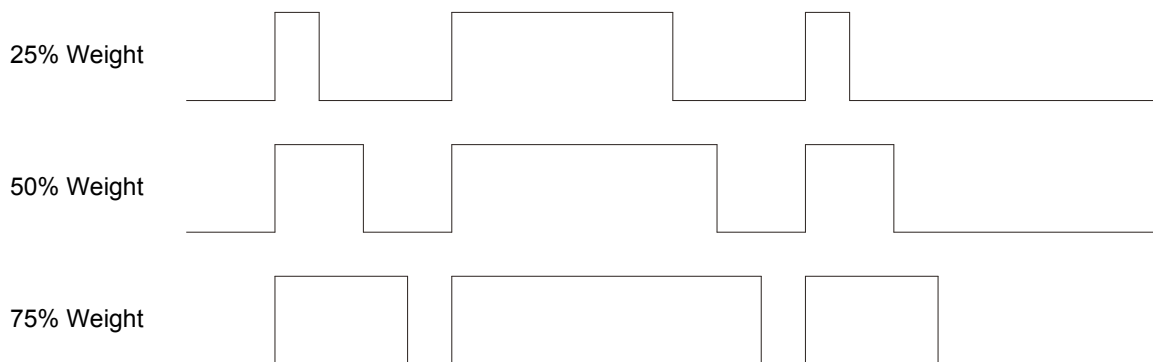

Figure 6: Code Weight.



### **Character Space**

The Character Space menu is used to increase the character space (normally three units) up to 12 units long. There are two numbers on line two of the display; the number enclosed within “[“ and “]” is the character spacing and the other number is the word spacing. Note the character space is always at least four units shorter than the word space. So you might have to increase the word spacing before adjusting the character space.

### **Word Space**

The Word Space menu is used to increase the word space (normally seven units) up to 16 units long. There are two numbers on line two of the display; the number enclosed within “[“ and “]” is the word spacing and the other number is the character spacing. Note the word space is always at least four units longer than the inter-character space.

### **Keying Compensation**

The Keying Compensation menu is used to increase the keying on-time and decrease the keying off-time up to 25 milliseconds (ms). Some radios have a key delay of 5 ms or more. By setting 5 milliseconds of compensation, the keyer will add 5 ms to the dots and dashes and subtract 5 ms from the intra-character spaces. Although similar to increasing weight, this adjustment is independent of the speed. This setting is used primarily to correct keying distortion by certain transceivers and to eliminate the problems with a transmitter key delay.

### **Keying Delay**

The Keying Delay menu is used to delay the keying output up to 20 milliseconds. This setting is used primarily to accommodate switching delay in certain station setup. It is used in conjunction with the PTT line to delay the keying output until all the switching is finished; that is, the keying output is lagged behind the sidetone audio and the PTT output. This controls the time between when PTT is asserted and when CW keying will start.

### **PTT Hang Time**

The PTT Hang Time menu is used to set the PTT hang time from 1 to 9999 milliseconds. This controls the time between when CW keying is ended and when the PTT will de-assert. You may adjust this to your liking for on-the-air sending. Press the “1” button and use the Set dial control to change time in increments of 1 ms; press the “100” button and use the Set dial control to change time in increments of 100 ms.

<p><b>Note:</b> If Keying Delay and PTT Hang Time are equal to zero, the PTT Output waveform will be identical to the Keying Output waveform.</p>
---

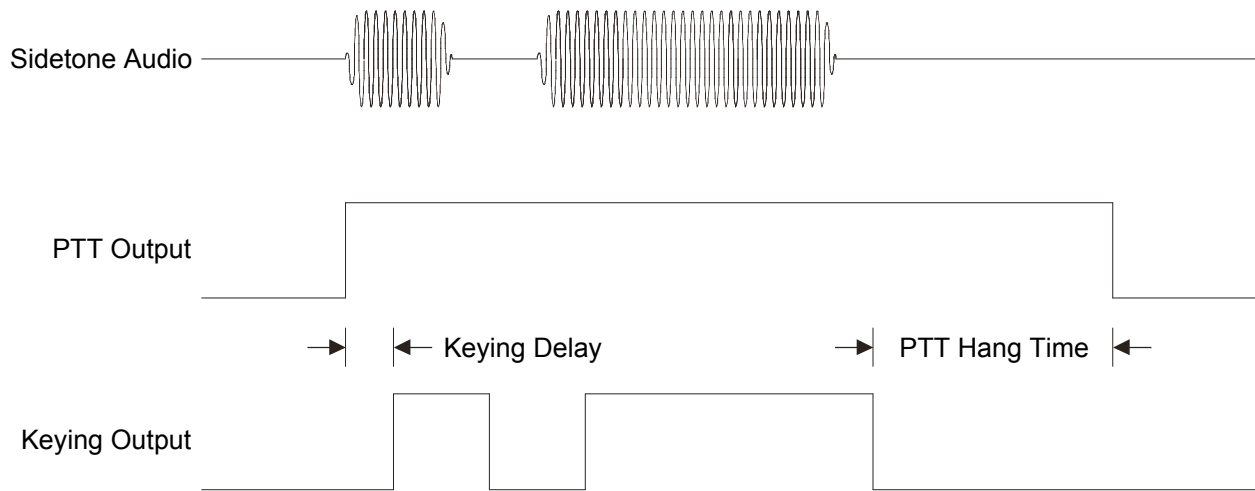

Figure 7: Keying Delay and PTT Hang Time Timing.

**Tone**

The Tone menu allows you to set the audio frequency in the range of 305 to 1006 Hz. The MFJ-464 features smooth, clean audio, with sine wave output, instead of the harsh square wave audio used by many other keyers. Also, the MFJ-464 produces each dit and dah with a rise and decay time of approximately 5 milliseconds, avoiding the "spikes" that cause distracting key clicks. The MFJ-464's audio sounds like that of a good CW transceiver.

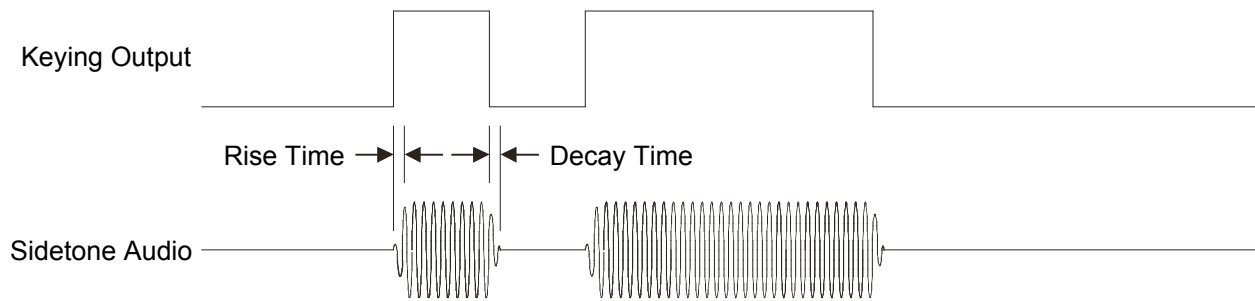

Figure 8: Rise Time and Decay Time Timing.

**Serial Number**

The Serial Number menu allows you to set the current serial number from 0001 to 9999. Press the “1” button and use the Set dial control to change number in increments of 1; press the “100” button and use the Set dial control to change number in increments of 100. Only three digits are sent for numbers below 1000—use leading zeroes when appropriate. The serial number is automatically post-incremented each time it is sent. Serial number 9999 will wrap-around to 0001, skipping 0000 since it is not used. Use Leading Zeroes, Other Zeroes and Nines menus to control the way zeroes and nines in the serial number are sent (see below). There are a four-digit number and three single characters on line two of the display. The four-digit number enclosed within “[” and “]” is the serial number.

**Leading Zeroes**

The Leading Zeroes menu is used to set whether the leading zeroes in the serial number are sent as “0”, “O”, “T” or not at all. There are a four-digit number and three single characters on line two of the display. The character enclosed within “[” and “]” is the replacement for the leading zeroes in the serial number.

**Other Zeroes**

The Other Zeroes menu is used to set whether the non-leading zeroes in the serial number are sent as “0”, “O” or “T”. There are a four-digit number and three single characters on line two of the display. The character enclosed within “[” and “]” is the replacement for the other zeroes in the serial number.

**Nines**

The Nines menu is used to set whether the nines in the serial number are sent as “9” or “N”. There are a four-digit number and three single characters on line two of the display. The character enclosed within “[” and “]” is the replacement for the nines in the serial number.

**Iambic**

The Iambic menu allows you to enable or disable iambic operation. Iambic operation allows you to squeeze both paddles and get alternating dots and dashes. There are two different types of iambic keying, and both are available. The difference in behavior of these two modes occurs when both paddles are squeezed and then released. In iambic A mode, the keyer will simply complete the element (dot or dash) in progress, and then stop sending. In iambic B mode, the keyer will complete the element in progress, and then send an additional opposite element. For example, a release during the dash produces "dit-dah" (A) in iambic A mode but produces "dit-dah-dit" (R) in iambic B mode. Non-iambic mode does not alternate between dots and dashes during a squeeze. It plays whatever side made contact first until it is released. That is, when iambic mode is disabled there are no dot and dash memories.

### Reverse

The Reverse menu allows you to reverse the paddles designation. When using paddles, the MFJ-464 normally expects the dot paddle to be connected to the tip of the plug and the dash paddle to be connected to the plug's ring. If your paddles are wired in the opposite manner, or you wish to change between right and left-handed operators, you may turn Reverse ON to switch the paddle functions. You can also set this mode by simply pressing the paddle you desire to designate as the dot paddle.

### Paddle

The Paddle menu allows you to select how the paddle works. With the automatic option, the keyer functions as an iambic keyer for use with a dual-lever paddle. As an iambic keyer, the MFJ-464 has dot and dash memories, for "squeeze keying," and functions just like other iambic keyers, both standalone keyers and those built into radios. With the semi-auto option, the keyer can be used with a single-lever key, with dots generated automatically and dashes formed manually by the user. This emulates the function of a mechanical semi-automatic "bug." You also may use this unit with a straight key or a bug, connect the straight key or bug to the ground and the dash line. With the hand-key option, both the dot and dash lines can be used to connect to a straight key. Notice hand-key mode may not be used to enter messages or setup commands.

**Note:** In hand-key mode using the paddle, the MFJ-464 will not display the code sent or record to the keyer memory. Also, the difference between this and the Handkey command is that this command affects the paddle only.

### Monitor

The Monitor menu is used to toggle the sidetone speaker on and off. If the sidetone is turned off, it will still play command messages and status information. To conserve power, the keyer should be operated with the monitor off in favor of the rig's sidetone.

### Output

The Output menu is used to toggle the keying output on and off. If the output is turned off, no signal goes to the Keying Output or the PTT Output to allow practice operation. The output is temporarily disabled during memory message storing, command mode operation, status information, and keyer setup.

### Queue

The Queue menu is used to toggle the message queue on and off. Queue mode enables the user to load messages into a buffer to play sequentially. In queue mode, if you press a message button while a message is playing, that message will play after the current message is done. When queue mode is off, pressing a message button will abort any message being played and play the new message. When on, up to eight button presses are stored in order and acted upon in succession as each message is completed.

**Note:** Disabling the queue mode increases the message stack size to seven levels deep used by the embedded Call command.

# The Reader

## Using the MFJ-464 CW Reader

The MFJ-464 comes complete with a CW Reader. The CW Reader on the MFJ-464 is a Morse code decoder that is displayed on a two-line 32-character LCD (liquid crystal display). It can auto-track CW up to 99 WPM (words per minute), and has a volatile repeat buffer memory of 140 characters.

The Reader on the MFJ-464 functions in two different ways. It decodes and displays the Morse code being sent and the Morse code being received. The LCD screen displays on the first (upper) line the code that is being sent and on the second (lower) line the code that is being received.

## Operation

Connect the proper cables from the MFJ-464 to your radio. If you cannot remember where the cables properly go, then see the Back Panel section of the manual on page 3. Power on your receiver and tune it to find a clear, well-sent Morse code signal. When you have found one, power on the MFJ-464. If necessary, adjust the Input Level control on your radio so that the Lock LED is blinking. Now tune in the signal again on your radio to adjust its frequency (to match the PLL frequency) until you get the maximum response from the LED. Next, turn the Input Level control on your radio until the LED is blinking in sync with the Morse code. Wait for the LCD screen to start displaying something that makes sense. Once it has tracked the signal, read the messages as they scroll across the LCD screen. Repeat these steps a few times to get the best response.

**IMPORTANT:** You can adjust the Input Level and Tune the signal directly on the MFJ-464. However, it is recommended that you do these adjustments on your radio and not on the MFJ-464. Changing the Input Level and the Tuning the signal on the MFJ-464 can cause problems when trying to listen to another signal. These adjustments are much easier to do on your radio than on the unit itself.

The Reader automatically locks on and tracks low and high speed Morse code, decoding it up to 99 WPM. When the unit is locked the green LED labeled LOCK will light. Its initial power-on tracking speed is 20 WPM. It will take some time to track an incoming signal or to re-track an extremely slow signal after copying a fast one and vice versa. If there is a lot of static, it will take time to track slow signals. This is because the static appears to the Reader as high speed Morse code.

There is a lot of sloppy code on the air and most computers cannot read them. Do not expect this Reader to do the incredible when it comes to copying Morse code. Nothing can clean up and copy a sloppy fist, especially with a weak signal and lots of QRM/QRN (interferences). However, you will be quite pleased when copying strong well-sent code, especially those sent with electronic keyers. Farnsworth code\* and extremely negative weighted code will display with spaces between each character. Finally, invalid characters are displayed as block characters on the LCD screen and as spaces on the computer monitor. Prosigns (procedural signs) are enclosed within "<<" and ">>" such as <AR> and <SN>.

## The Paddle

### Using the MFJ-464 with a Paddle

Plug an iambic or single lever paddle into the Key Input jack of the MFJ-464. A  $\frac{1}{4}$ -inch stereo phone plug and a two-conductor shielded cable should be used. If separate shielded cables are used, the two shields should be tied together and connected to ground. The dot wire should be connected to the tip of the plug and the dash wire to the ring. Begin sending code using the paddles. If you would like to change speed, sidetone or weight, see the sections pertaining to these commands.

The iambic paddle has a unique feature that the single lever paddle does not have. Notice that the two paddles are independent and can be squeezed together. Both the dot and dash contacts touch the chassis, therefore ground. The MFJ-464 senses this happen and uses it as a separate keying mode.

Iambic keying has two modes: A and B. When a squeeze is released during an element (dot or dash), iambic B adds an opposite element. Iambic A just finishes the element in progress and does not produce a following alternate element.

The dot and dash memories make sending easier. The memories allow the user to key a dot before the completion of a dash and vice versa. This feature can be checked by setting the keyer to the lowest speed and tapping first the dash lever and then the dot lever before the completion of the dash. The keyer will provide both the dash and the dot. The dash memory can be checked in a similar manner. The dot insertion feature allows the user to insert a dot by tapping the dot lever while holding the dash lever in. The dash insertion feature allows the user to insert a dash while holding the dot lever in. The iambic operation allows sending alternate dots and dashes when both levers are squeezed. The first lever contacted will determine whether a dot or dash occurs first.

**Note:** It is recommended the Farnsworth mode be disabled when sending with the paddle. When Farnsworth mode is enabled, the paddle will send code at the Farnsworth speed, not the overall speed.

## **Message Memory**

To play a message, press and release the corresponding message button MSG1 to MSG4. The message will play and send to your radio. To save a message to memory, press and hold a message button for two seconds until the keyer plays "GO" (dah-dah-dit dah-dah-dah) in Morse code. You may now key in a message using the paddle.

Begin keying your message. As you pause after every word, the keyer will insert a word break. If the keyer does not recognize your code as a valid character, the keyer will display a block character and that character will not be saved. Continue keying in the rest of the word.

If you make a mistake entering a word, you can back up over it by keying in at least 10 continuous dots. The keyer will erase the previous word. Also, press the Mode button momentarily will delete the last character; press and hold the Mode button for two seconds will delete the last word.

At the end of your message, press and hold any of the four message buttons for two seconds to end your message. The keyer will respond by sending an end-of-message character (di-dah-di-dah-dit) and automatically insert "]" to the end of your message.

Refer to "The Memory" section on page 35 for explanation of the MFJ-464's message memory and how to use the embedded commands to enhance your message.

# The Keyboard

## Using the MFJ-464 with a Keyboard

### Quick Mode

The quick mode menus allow you to set up how the keyboard works and behaviors. There are three quick mode menus arranged in a “wrap-around” structure. To access these quick menus, press and hold both the Mode and MSG1 buttons while turning the power on. The quick menu that will display is the one that was last used. When finishing, press the Mode button to go to the main mode for normal operation.

Within each quick menu:

- Press the Mode button to exit the quick mode and go to the main mode.
- Press the Next button to view the next quick menu; press the Previous button to view the previous quick menu.
- Turn the Set dial control to toggle the setting for that quick menu.

### Keyboard Layout

The Keyboard Layout menu set the type of keyboard to be used. The MFJ-464 can be used with either a Qwerty or a Dvorak keyboard.

### Repeat

The Repeat menu set whether or not to repeat a key when it is held down.

### Caps Lock

The Caps Lock menu set the power-on Caps Lock status of the keyboard.

## Keyboard Operation

When you plug in a standard IBM style AT keyboard, your keyer becomes a powerful keyboard keyer. The MFJ-464 uses the letter keys A-Z, the number keys 0-9, the function keys F1-F12, the space bar, the arrow keys, and the punctuation characters that have Morse equivalents. Prosings have been assigned to some of the other punctuation characters for quick operation. See the appendix “Morse Code Character Set” on page 43.

The operation of the keyboard is simple. Begin typing on the keyboard. Typed characters are sent at the code speed of the keyer. If a typing mistake occurs, the BACK SPACE key can be pressed to erase the last character *before* it is sent. If you want to purge all the text in the buffer that has not yet been sent, press the ESC key. Pressing PAUSE during transmission stops playback of the buffer text and allows entry with the paddle; press ESC *once* resumes playback of the buffer text from where it was interrupted (pressing ESC *twice* will abort the message playback).



When typing speed is greater than the code speed, characters will begin to fill a type-ahead buffer. The code sent to the radio and over the sidetone speaker will lag behind the typing of each character. Most of the time this will not cause a problem. Only for very fast typists that send slow code will the type ahead buffer fill significantly. The maximum size of the type-ahead buffer is 190 characters. When the buffer fills to 180 characters, the sidetone will be higher. This is a signal to slow typing speed because when the buffer fills to 190 characters each new key-press will be lost. It is best to never type much faster than your code speed.

Transmitted characters and buffer memory may be monitored using the LCD display on the MFJ-464. This readout is comprised of two lines of text, each containing 16 characters. The top line shows the characters currently being transmitted. The bottom line normally shows the received characters. The bottom line can show the content of the type-ahead buffer memory; this buffer line is toggled on and off with the PRINT SCREEN key. Note that non-ASCII characters, such as CTRL, ALT, SHIFT, etc., are displayed as a block character on the buffer line.

If you want to send a special prosign, you can enclose it in “<” and “>”. To make a special prosign, begin the prosign with “<”, type the characters of the prosign, and end the prosign with “>”. For example, to make the prosign  $\overline{SN}$  types <SN>. This will remove the inter-character spaces between the characters making it a prosign. Any prosign can be made this way, even special local prosigns. Another method is to enclose the prosign with backslashes such as \SN\. An easier way to send special prosign is press ALT key, type the characters of the prosign, and then release the ALT key (this method does not work within the terminal program as the ALT key is reserved for other functions).

<p><b>Note:</b> The open angle bracket “&lt;” enables prosign mode and the close angle bracket “&gt;” disables prosign mode; while the backslash “\” toggles the prosign mode on and off. In addition, pressing the ALT key enables prosign mode and releasing disables it. A word space also disables prosign mode.</p>
--

## Keyboard Key Combinations

Press a modifier key (CTRL, ALT or SHIFT) in combination with another key to perform special functions or shortcuts. Note that these key combinations do not work in the Terminal mode, because these modifier keys are reserved for the computer uses.

Key	Normal	Shift	Alt	Ctrl
A	a	A	Custom Prosign	
B	b	B	Custom Prosign	
C	c	C	Custom Prosign	Set Character Space
D	d	D	Custom Prosign	Decrement Number
E	e	E	Custom Prosign	
F	f	F	Custom Prosign	Set Farnsworth
G	g	G	Custom Prosign	Set Word Space (Gap)
H	h	H	Custom Prosign	Hand Key
I	i	I	Custom Prosign	Set Iambic
J	j	J	Custom Prosign	Set Hang Time
K	k	K	Custom Prosign	Set Key Compensation
L	l	L	Custom Prosign	Set Key Delay (Lag)
M	m	M	Custom Prosign	Set Monitor
N	n	N	Custom Prosign	Set Number
O	o	O	Custom Prosign	Set Output
P	p	P	Custom Prosign	Set Paddle
Q	q	Q	Custom Prosign	Set Queue
R	r	R	Custom Prosign	
S	s	S	Custom Prosign	Set Speed
T	t	T	Custom Prosign	Set Tone
U	u	U	Custom Prosign	
V	v	V	Custom Prosign	Reverse
W	w	W	Custom Prosign	Set Weights
X	x	X	Custom Prosign	Carrier Tune (Xmit)
Y	y	Y	Custom Prosign	Pulse Tune
Z	z	Z	Custom Prosign	Set Zeroes & Nines
F1	Play Message 1			Program Message 1
F2	Play Message 2			Program Message 2
F3	Play Message 3			Program Message 3
F4	Play Message 4			Program Message 4
F5	Decrement Number			
F6	Increment Number			
F7	Repeat Reader Buffer			
F8	Freeze Reader Buffer			
F9	Get Quick Speed 1			Set Quick Speed 1
F10	Get Quick Speed 2			Set Quick Speed 2
F11	Get Quick Speed 3			Set Quick Speed 3
F12	Get Quick Speed 4			Set Quick Speed 4

Key	Normal	Shift	Alt	Ctrl
◻ LEFT	Decrease Setting	Tone -1 Step	Weight -1%	Speed -1 WPM
◻ RIGHT	Increase Setting	Tone +1 Step	Weight +1%	Speed +1 WPM
◻ DOWN	Decrease Setting	Tone -5 Step	Weight -5%	Speed -5 WPM
◻ UP	Increase Setting	Tone +5 Step	Weight +5%	Speed +5 WPM
ESC	Abort/Cancel/Exit			
BACK SPACE	Delete Character			Delete Word
ENTER	End Message			
PRINT SCREEN	Display Type Ahead Buffer			
SCROLL LOCK	Freeze Reader Buffer			
PAUSE	Pause			
~	Enter setup command mode			
\	Toggle prosign mode			
<	Decrease setting or enable prosign mode			
>	Increase setting or disable prosign mode			
[	Use the close square bracket "]" to end message allowing carriage returns in messages			
]	End message if selected by the open square bracket "["			

**Note:** The ◻(UP), ◻ (DOWN), ◻ (LEFT), and ◻ (RIGHT) keys are referred to as the Arrow keys in this manual.

## Setup Commands

Press the tilde “~” key to enter command mode and the keyer responds with “CO” (dah-di-dah-dit dah-dah-dah). Enter a setup command. If the command is invalid then the keyer will send an error character (di-di-di-di-di-di-dit) and return the keyer to normal mode. If the user wishes to re-attempt modifying features using command mode, he must re-enter command mode by pressing “~” key again. If you enter the command mode accidentally, press ESC key to exit. At any time, press ENTER to accept and exit or press ESC to cancel and exit. Alternately, pressing CTRL+Key to directly enter the command mode; that is, CTRL+S is the same as “~S”. To perform this action, press and hold the CTRL key, press a letter key B to Z, and then release the CTRL key. Refer to the appendix “Setup Commands” on page 46 for a table of these commands.

**C#** Character space – increases the inter-character space with # standard intra-character spaces, where # is a single digit from 0 to 9. This allows the normally three-unit long inter-character space up to 12 units long. Note the inter-character space is always at least four units shorter than the word space. Therefore, you might have to increase the word spacing before adjusting the character space.

Press LEFT or DOWN to decrease or press RIGHT or UP to increase the character spacing, or enter one digit 0 to 9 to set the character spacing. Press ENTER to accept and exit, or press ESC to cancel and exit.

**D**        **D**ecrement – decrements the serial number by one, effectively canceling the automatic increment applied when last played from a message. The decrement function accommodates re-sending the last serial number, as might be needed when a repeat of a contest exchange is requested, or canceling the exchange with a station that proved to be a “dupe”. The unit will echo a "D" (dah-di-dit) for every number that is decrement. Decrement serial number 0001 rolls over to 9999, because the number 0000 is not used.

**F##**      **F**arnsworth – uses to enable Farnsworth mode and spacing. Farnsworth spacing adds more time between characters to slow down the overall sending speed. The advantage of this is that, by hearing the characters sent at a faster speed, you learn to recognize each character by its distinctive rhythm, rather than by trying to "count dits." This greatly assists you in copying Morse code at higher speeds. The Farnsworth speed, however, must be higher than the overall speed. Setting ## to 00 or less than or equal to the overall speed will disable Farnsworth mode.

Press LEFT or DOWN to decrease or press RIGHT or UP to increase the speed, or enter two digits 10 to 99 to set the Farnsworth speed or 00 to turn off Farnsworth mode. Press ENTER to accept and exit, or press ESC to cancel and exit

**Note:** It is recommended the Farnsworth mode be disabled when sending with the paddle. When Farnsworth mode is enabled, the paddle will send code at the Farnsworth speed, not the overall speed.

**G#**        **G**ap (word space) – increases the word space with # standard intra-character spaces, where # is a single digit from 0 to 9. This allows the normally seven-unit long word space up to 16 units long. Note the word space is always at least four units longer than the inter-character space.

Press LEFT or DOWN to decrease or press RIGHT or UP to increase the word spacing, or enter one digit 0 to 9 to set the word spacing. Press ENTER to accept and exit, or press ESC to cancel and exit.

**H**        **H**and key – enters the hand key mode to use the SPACE key as a hand (straight) key. The keyer responds with "HK" (di-di-di-dit dah-di-dah). Dots and dashes are made manually by using the space bar on your keyboard. That is, keying follows closure of the dot or dash paddle or the SPACE key, allowing hand-sent code. Normal keyer operation is regained by squeezing both paddles or by pressing the ESC key.

**I#**        **I**ambic – enables iambic A or B mode where # represents A or B, or disables iambic operation with # = N. The keyer will respond with "A" (di-dah), "B" (dah-di-di-dit), or "OFF" (dah-dah-dah di-di-dah-dit di-di-dah-dit). Press ESC to cancel and exit.

**J#####**    **P**TT hang time – sets the PTT (push-to-talk) hang time to ##### millisecond, where ##### represents four digits in the range of 0001 to 9999. This controls the time between when CW keying is ended and when the PTT will de-assert. You may adjust this to your liking for on-the-air sending.

Press LEFT or DOWN to decrease or press RIGHT or UP to increase the hang time, or enter up to four digits 0001 to 9999 to set the hang time. Press ENTER to accept and exit, or press ESC to cancel and exit.

- K##**      **Keying compensation** – sets the keying compensation to ## millisecond, where ## represents two digits in the range of 00 to 25. Some radios have a key delay of 5 ms or more. By entering K05, the keyer will add 5 ms to the dots and dashes and subtract 5 ms from the intra-character spaces. Although similar to increasing weight, this adjustment is independent of the speed. This setting is used primarily to correct keying distortion by certain transceivers and to eliminate the problems with a transmitter key delay.
- Press LEFT or DOWN to decrease or press RIGHT or UP to increase the compensation, or enter up to two digits 00 to 25 to set the compensation time. Press ENTER to accept and exit, or press ESC to cancel and exit.
- L##**      **Lag (keying delay)** – sets the keying delay to ## millisecond, where ## represents two digits in the range of 00 to 20. This setting is used primarily to accommodate switching delay in certain station setup. It is used in conjunction with the PTT line to delay the keying output until all the switching is finished; that is, the keying output is lagged behind the sidetone audio and the PTT output. This controls the time between when PTT is asserted and when CW keying will start.
- Press LEFT or DOWN to decrease or press RIGHT or UP to increase the delay, or enter up to two digits 00 to 20 to set the delay time. Press ENTER to accept and exit, or press ESC to cancel and exit.
- M#**      **Monitor** – enables (#=Y) or disables (#=N) the sidetone monitor, or toggles the sidetone monitor on or off without the #. If the sidetone is turned off, it will still play command messages and status information. To conserve power, the keyer should be operated with the monitor off in favor of the rig's sidetone.
- To change Monitor mode type “~M” followed by “Y” for on, “N” for off, or ENTER to toggle. The keyer will respond with “ON” or “OFF”. Press ESC or any other key to cancel and exit.
- N####**      **Number** – sets the serial number. The serial number can be set from 0000 to 9999 (0000 will be converted to 0001). Enter up to four digits to set the current serial number and press ENTER to accept and exit, or press ESC to cancel and exit.
- O#**      **Output** – enables (#=Y) or disables (#=N) the keying output, or toggles the keying output on or off without the #. If the output is turned off, no signal goes to the Keying Output or the PTT Output to allow practice operation. The output is temporarily disabled during memory message storing, command mode operation, status information, and keyer setup.
- To change Output mode type “~O” followed by “Y” for on, “N” for off, or ENTER to toggle. The keyer will respond with “ON” or “OFF”. Press ESC or any other key to cancel and exit.

**P#** **Paddle** – selects paddle mode of automatic (**#=A**), semi-automatic (bug, **#=S**) or hand-key (**#=H**) mode. With the automatic option, the keyer functions as an iambic keyer for use with a dual-lever paddle. As an iambic keyer, the MFJ-464 has dot and dash memories for "squeeze keying" and functions just like other iambic keyers, both standalone keyers and those built into radios. With semi-auto, the keyer can be used with a single-lever key, with dots generated automatically and dashes formed manually by the user. This emulates the function of a mechanical semi-automatic "bug." You also may use this unit with a straight key or a bug, connect the straight key or bug to the ground and the dash line. With the hand-key option, both the dot and dash lines can be used to connect to a straight key. Notice hand-key mode may not be used to enter messages or commands.

**Note:** In hand-key mode using the paddle, the MFJ-464 will not display the code sent or record to the keyer memory. Also, the difference between this and the Hand-key command is that this command affects the paddle only.

**Q#** **Queue** – enables (**#=Y**) or disables (**#=N**) the message queue, or toggles the message queue on or off without the **#**. Queue mode enables the user to load messages into a buffer to play sequentially. In queue mode, if you press a message button while a message is playing, that message will play after the current message is done. When queue mode is off, pressing a message button will abort any message being played and play the new message. When on, up to eight button presses are stored in order and acted upon in succession as each message is completed.

To change Queue mode type “~Q” followed by “Y” for on, “N” for off, or ENTER to toggle. The keyer will respond with “ON” or “OFF”. Press ESC or any other key to cancel and exit.

**Note:** Disabling the queue mode increases the message stack size to seven levels deep used by the embedded Call command.

**S##** **Speed** – sets the overall code speed to **##** WPM, where **##** represents two digits in the range of 05 to 99. By "overall" speed, we mean the speed at which the words or groups are sent. A "word" is defined as 50 units of time, and the word "PARIS" is exactly 50 units in length. Therefore, if "PARIS" is sent 13 times in one minute, the sending speed is 13 wpm.

Standard Morse code timing defines a dit as one unit of time and a dah as three units of time. Within each character, there is one unit between elements (dits and dahs). Three units separate characters and seven units separate words. Farnsworth spacing (see above) will increase the amount of time between characters and words. Note that setting the overall speed greater than or equal to the Farnsworth speed will disable Farnsworth spacing.

Press LEFT or DOWN to decrease or press RIGHT or UP to increase the code speed, or enter up to two digits 05 to 99 to set the code speed. Press ENTER to accept and exit, or press ESC to accept and exit.

- T##** **Tone** – sets the sidetone frequency to approximately ##0 Hz, where ## represents two digits in the range of 30 to 99. The MFJ-464 features smooth, clean audio, with sine wave output, instead of the harsh square wave audio used by many other keyers. Also, the MFJ-464 produces each dit and dah with a rise and decay time of approximately five milliseconds, avoiding the "spikes" that cause distracting key clicks. The MFJ-464's audio sounds like that of a good CW transceiver.
- Notice an alternating series of dots and dashes are sent to the sidetone monitor to assist in the setting of the desired sidetone frequency. Press LEFT or DOWN to decrease or press RIGHT or UP to increase the tone frequency, or enter two digits 30 to 99 to set the tone frequency. Press ENTER to accept and exit, or press ESC to cancel and exit.
- V** **reVerse** – reverses the sense of the dot and dash paddles. When using paddles, the MFJ-464 normally expects the dot paddle to be connected to the tip of the plug and the dash paddle to be connected to the plug's ring. If your paddles are wired in the opposite manner, or you wish to change between right and left-handed operators, you may reverse the paddles.
- W##** **Weight** – sets the code weighting to ## percent, where ## represents two digits in the range of 25 to 75. Weight is the duty cycle of a continuous string of dots, where 50% for perfect code. A higher weight produces a heavier sound and a lower weight causes characters to sound lighter.
- An alternating dot/dash is produced to aid in changing the weight. Press LEFT or DOWN to decrease or press RIGHT or UP to increase the weight, or enter two digits 25 to 75 to set the weight. Press ENTER to accept and exit, or press ESC to cancel and exit.
- X** **Xmit (carrier tune)** – gives continuous key-down for adjusting transmitter or antenna tuner. Press any key to exit and release the key line.
- Y** **Pulse tune** – gives continuous adjustable pulses for adjusting transmitter or antenna tuner. Press MSG1 and MSG2 buttons to change the speed in the range of 50 to 99 WPM. Press MSG3 and MSG4 buttons to change the weight (duty cycle) in the range of 1% to 35%. Press ESC to exit and release the key line.
- Alternately, use CTRL+Arrow keys to change the pulse speed and ALT+Arrow keys to change the pulse weight.
- Z###** **Zeros and nines** – sets the way zeros and nines in the serial number are sent. The first # sets whether to send the leading zeros as "0", "O", "T" or not at all (# = "N"). The second # sets whether the other zeros are sent as "0", "O" or "T". The last # sets whether the nines are sent as "9" or "N". For example, "ZO09" will send the leading zeros as "O" (dah-dah-dah), the other zeros as "0" (dah-dah-dah-dah-dah), and the nines as "9" (dah-dah-dah-dah-dit).
- #** **Play message** – play message #, where # is the message number 1 to 4. Alternately, press F1 to F4 to play the corresponding message.
- >#** **Save message** – save message into the keyer memory #, where # is the message number 1 to 4. Alternately, press CTRL+F1 to CTRL+F4 to save messages.
- <#** **View message** – view message #, where # is the message number 1 to 4.

## Message Memory

With the keyboard, you can play or save messages using the keyboard function keys. To play a message, press any keyboard function key F1 to F4. The message will play and send to your radio. Press CTRL+Arrow keys to change the overall speed on the fly, press ALT+Arrow keys to change the weight on the fly, and press SHIFT+Arrow keys to change the tone on the fly.

To save a message to memory, press and hold the CTRL key, press the keyboard function key F1 to F4, and then release the CTRL key (this is denoted as CTRL+Fn). The keyer will respond with "GO" (dah-dah-dit dah-dah-dah). Now a message can be typed into memory.

Begin typing in your message pressing the space bar between words. The keyer echoes each character as it is typed. Press the BACK SPACE key to delete the last character. In message program mode *only*, press CTRL+BACK SPACE to delete the last word.

At the end of your message, press ENTER to end your message. The keyer will respond by sending an end-of-message character (di-dah-di-dah-dit) and save your message. It will automatically insert "]" to the end of your message.

If you accidentally enter "[" during the message, you will have to use "]" to end your message – this allows carriage returns (produced by ENTER) in the message. The open square bracket "[" tells the keyer to replace the ENTER key with the close square bracket "]" as the end-of-message key.

Refer to "The Memory" section on page 35 for explanation of the MFJ-464's message memory and how to use the embedded commands to enhance your message.

## Quick Speeds

There are four pre-set memories to store the overall speed, so the speed can be quickly changed during an exchange. This works similar to your car radio's pre-set station memories. To store the current overall speed into one of these pre-set memories, press CTRL+F9 to CTRL+F12. To recall a pre-set speed to use as the current speed, press F9 to F12.



# The Terminal

## Using the MFJ-464 with a Terminal Program

The Keyer Terminal mode allows a computer to talk to your MFJ-464. All code sent from the paddle and keyboard is echoed to the Keyer Terminal. All commands are accessible through the Keyer Terminal.

Your computer will need a terminal program to talk to the keyer. The program should be capable of uploading and downloading ASCII text files. Any good commercial or freeware terminal program should be satisfactory for use with this keyer.

After you have connected the MFJ-464 to the serial port of your computer with the correct cable, turn on your computer and load your terminal program. Set the baud rate to 9600, data bits to 8, parity to none, and stop bits to 1. Also, set the flow control to Xon/Xoff. Now turn on your MFJ-464. You should type something on the computer. Whatever you type should appear on the LCD display, which shows that everything is working properly between the computer and keyer. If you do not, recheck your terminal program and serial port cable connection.

You are ready to send with the keyer. To make a special prosign with the keyer terminal, begin the prosign with "<" and end the prosign with ">". For example, to make the prosign  $\overline{SN}$  types <SN>. This will remove the inter-character spaces between the characters making it a prosign. Any prosign can be made this way, even special local prosigns. Another method is to enclose the prosign with backslashes such as \SN\.

**Note:** The open angle bracket "<" enables prosign mode and the close angle bracket ">" disables prosign mode; while the backslash "\" toggles the prosign mode on and off. A word space also disables prosign mode.

**Tip:** All keystrokes and commands from the Keyer Terminal can also be used via the Keyboard.

## Setup Commands

Press the tilde "~" key to enter command mode and the keyer responds with "CO" (dah-di-dah-dit dah-dah-dah). Enter a setup command. If the command is invalid then the keyer will send an error character (di-di-di-di-di-di-di-dit) and return the keyer to normal mode. If the user wishes to re-attempt modifying features using command mode, he must re-enter command mode by pressing "~" key again. If you enter the command mode accidentally, press ESC key at any time to exit. At any time, press ENTER to accept or ESC to cancel. Refer to the appendix "Setup Commands" on page 46 for a table of these commands.

**C#** Character space – increases the inter-character space with # standard intra-character spaces, where # is a single digit from 0 to 9. This allows the normally three-unit long inter-character space up to 12 units long. Note the inter-character space is always at least four units shorter than the word space. Therefore, you might have to increase the word spacing before adjusting the character space.

Press either the “<” or “>” to decrease or increase character spacing, or enter one digit 0 to 9 to set the character spacing. Press ENTER to accept and exit, or press ESC to cancel and exit.

**D** Decrement – decrements the serial number by one, effectively canceling the automatic increment applied when last played from a message. The decrement function accommodates re-sending the last serial number, as might be needed when a repeat of a contest exchange is requested, or canceling the exchange with a station that proved to be a “dupe”. The unit will echo a "D" (dah-di-dit) for every number that is decrement. Decrement serial number 0001 rolls over to 9999, because the number 0000 is not used.

**F##** Farnsworth – uses to enable Farnsworth mode and spacing. Farnsworth spacing adds more time between characters to slow down the overall sending speed. The advantage of this is that, by hearing the characters sent at a faster speed, you learn to recognize each character by its distinctive rhythm, rather than by trying to "count dits." This greatly assists you in copying Morse code at higher speeds. The Farnsworth speed, however, must be higher than the overall speed. Setting ## to 00 or less than or equal to the overall speed will disable Farnsworth mode.

Press either the “<” or “>” to decrease or increase speed, or enter two digits 10 to 99 to set the Farnsworth speed or 00 to turn off Farnsworth mode. Press ENTER to accept and exit, or press ESC to cancel and exit

**Note:** It is recommended the Farnsworth mode be disabled when sending with the paddle. When Farnsworth mode is enabled, the paddle will send code at the Farnsworth speed, not the overall speed.

**G#** Gap (word space) – increases the word space with # standard intra-character spaces, where # is a single digit from 0 to 9. This allows the normally seven-unit long word space up to 16 units long. Note the word space is always at least four units longer than the inter-character space.

Press either the “<” or “>” to decrease or increase word spacing, or enter one digit 0 to 9 to set the word spacing. Press ENTER to accept and exit, or press ESC to cancel and exit.

**H** Hand key – enters the hand key mode to use the SPACE key as a hand (straight) key. The keyer responds with "HK" (di-di-di-dit dah-di-dah). Dots and dashes are made manually by using the space bar on your keyboard. That is, keying follows closure of the dot or dash paddle or the SPACE key, allowing hand-sent code. Normal keyer operation is regained by squeezing both paddles or by pressing the ESC key.

**Tip:** The space bar on the keyer terminal does not work properly in hand-key mode, because of the typematic delay of the computer keyboard.

- I#** **Iambic** – enables iambic A or B mode where # represents A or B, or disables iambic operation with # = N. The keyer will respond with "A" (di-dah), "B" (dah-di-di-dit), or "OFF" (dah-dah-dah di-di-dah-dit di-di-dah-dit). Press ESC to cancel and exit.
- J####** **PTT hang time** – sets the PTT (push-to-talk) hang time to #### millisecond, where #### represents four digits in the range of 0001 to 9999. This controls the time between when CW keying is ended and when the PTT will de-assert. You may adjust this to your liking for on-the-air sending.
- Press either the "<" or ">" to decrease or increase the hang time, or enter up to four digits 0001 to 9999 to set the hang time. Press ENTER to accept and exit, or press ESC to cancel and exit.
- K##** **Keying compensation** – sets the keying compensation to ## millisecond, where ## represents two digits in the range of 00 to 25. Some radios have a key delay of 5 ms or more. By entering K05, the keyer will add 5 ms to the dots and dashes and subtract 5 ms from the intra-character spaces. Although similar to increasing weight, this adjustment is independent of the speed. This setting is used primarily to correct keying distortion by certain transceivers and to eliminate the problems with a transmitter key delay.
- Press either the "<" or ">" to decrease or increase compensation, or enter up to two digits 00 to 25 to set the compensation time. Press ENTER to accept and exit, or press ESC to cancel and exit.
- L##** **Lag (keying delay)** – sets the keying delay to ## millisecond, where ## represents two digits in the range of 00 to 20. This setting is used primarily to accommodate switching delay in certain station setup. It is used in conjunction with the PTT line to delay the keying output until all the switching is finished; that is, the keying output is lagged behind the sidetone audio and the PTT output. This controls the time between when PTT is asserted and when CW keying will start.
- Press either the "<" or ">" to decrease or increase delay, or enter up to two digits 00 to 20 to set the delay time. Press ENTER to accept and exit, or press ESC to cancel and exit.
- M#** **Monitor** – enables (#=Y) or disables (#=N) the sidetone monitor, or toggles the sidetone monitor on or off without the #. If the sidetone is turned off, it will still play command messages and status information. To conserve power, the keyer should be operated with the monitor off in favor of the rig's sidetone.
- To change Monitor mode type "~M" followed by "Y" for on, "N" for off, or ENTER to toggle. The keyer will respond with "ON" or "OFF". Press ESC or any other key to cancel and exit.
- N####** **Number** – sets the serial number. The serial number can be set from 0000 to 9999 (0000 will be converted to 0001). Enter up to four digits to set the current serial number and press ENTER to accept and exit, or press ESC to cancel and exit.

**O#**      **Output** – enables (#=Y) or disables (#=N) the keying output, or toggles the keying output on or off without the #. If the output is turned off, no signal goes to the Keying Output or the PTT Output to allow practice operation. The output is temporarily disabled during memory message storing, command mode operation, status information, and keyer setup.

To change Output mode type “~O” followed by “Y” for on, “N” for off, or ENTER to toggle. The keyer will respond with “ON” or “OFF”. Press ESC or any other key to cancel and exit.

**P#**      **Paddle** – selects paddle mode of automatic (#=A), semi-automatic (bug, #=S) or hand-key (#=H) mode. With the automatic option, the keyer functions as an iambic keyer for use with a dual-lever paddle. As an iambic keyer, the MFJ-464 has dot and dash memories for "squeeze keying" and functions just like other iambic keyers, both standalone keyers and those built into radios. With semi-auto, the keyer can be used with a single-lever key, with dots generated automatically and dashes formed manually by the user. This emulates the function of a mechanical semi-automatic "bug." You also may use this unit with a straight key or a bug, connect the straight key or bug to the ground and the dash line. With the hand-key option, both the dot and dash lines can be used to connect to a straight key. Notice hand-key mode may not be used to enter messages or commands.

**Note:** In hand-key mode using the paddle, the MFJ-464 will not display the code sent or record to the keyer memory. Also, the difference between this and the Hand-key command is that this command affects the paddle only.

**Q#**      **Queue** – enables (#=Y) or disables (#=N) the message queue, or toggles the message queue on or off without the #. Queue mode enables the user to load messages into a buffer to play sequentially. In queue mode, if you press a message button while a message is playing, that message will play after the current message is done. When queue mode is off, pressing a message button will abort any message being played and play the new message. When on, up to eight button presses are stored in order and acted upon in succession as each message is completed.

To change Queue mode type “~Q” followed by “Y” for on, “N” for off, or ENTER to toggle. The keyer will respond with “ON” or “OFF”. Press ESC or any other key to cancel and exit.

**Note:** Disabling the queue mode increases the message stack size to seven levels deep used by the embedded Call command.

**S##**      **Speed** – sets the overall code speed to ## WPM, where ## represents two digits in the range of 05 to 99. By "overall" speed, we mean the speed at which the words or groups are sent. A "word" is defined as 50 units of time, and the word "PARIS" is exactly 50 units in length. Therefore, if "PARIS" is sent 13 times in one minute, the sending speed is 13 wpm.

Standard Morse code timing defines a dit as one unit of time and a dah as three units of time. Within each character, there is one unit between elements (dits and dahs). Three units separate characters and seven units separate words. Farnsworth spacing (see above) will increase the amount of time between characters and words. Note that

setting the overall speed greater than or equal to the Farnsworth speed will disable Farnsworth spacing.

Press either the "<" or ">" to decrease or increase speed, or enter up to two digits 05 to 99 to set the code speed. Press ENTER to accept and exit, or press ESC to accept and exit.

**T##** **Tone** – sets the sidetone frequency to approximately ##0 Hz, where ## represents two digits in the range of 30 to 99. The MFJ-464 features smooth, clean audio, with sine wave output, instead of the harsh square wave audio used by many other keyers. Also, the MFJ-464 produces each dit and dah with a rise and decay time of approximately 5 milliseconds, avoiding the "spikes" that cause distracting key clicks. The MFJ-464's audio sounds like that of a good CW transceiver.

Notice an alternating series of dots and dashes are sent to the sidetone monitor to assist in the setting of the desired sidetone frequency. Press either the "<" or ">" to decrease or increase tone frequency, or enter two digits 30 to 99 to set the tone frequency. Press ENTER to accept and exit, or press ESC to cancel and exit.

**V** **reVerse** – reverses the sense of the dot and dash paddles. When using paddles, the MFJ-464 normally expects the dot paddle to be connected to the tip of the plug and the dash paddle to be connected to the plug's ring. If your paddles are wired in the opposite manner, or you wish to change between right and left-handed operators, you may reverse the paddles.

**W##** **Weight** – sets the code weighting to ## percent, where ## represents two digits in the range of 25 to 75. Weight is the duty cycle of a continuous string of dots, where 50% for perfect code. A higher weight produces a heavier sound and a lower weight causes characters to sound lighter.

An alternating dot/dash is produced to aid in changing the weight. Press either the "<" or ">" key to change the weight, or enter two digits 25 to 75 to set the weight. Press ENTER to accept and exit, or press ESC to cancel and exit.

**X** **Xmit (carrier tune)** – gives continuous key-down for adjusting transmitter or antenna tuner. Press any key to exit and release the key line.

**Y** **Pulse tune** – gives continuous adjustable pulses for adjusting transmitter or antenna tuner. Press MSG1 and MSG2 buttons to change the speed in the range of 50 to 99 WPM. Press MSG3 and MSG4 buttons to change the weight (duty cycle) in the range of 1% to 35%. Press ESC to exit and release the key line.

**Z###** **Zeros and nines** – sets the way zeros and nines in the serial number are sent. The first # sets whether to send the leading zeros as "0", "O", "T" or not at all (# = "N"). The second # sets whether the other zeros are sent as "0", "O" or "T". The last # sets whether the nines are sent as "9" or "N". For example, "ZO09" will send the leading zeros as "O" (dah-dah-dah), the other zeros as "0" (dah-dah-dah-dah-dah), and the nines as "9" (dah-dah-dah-dah-dit).

**#** **Play message** – play message #, where # is the message number 1 to 4.

**>#** **Save message** – save message into the keyer memory #, where # is the message number 1 to 4.

**<#** **View message** – view message #, where # is the message number 1 to 4.

## Message Memory

To play a message in the terminal mode, type `~#` where # is the message number 1 to 4. The message is sent to the radio and echoed back to the terminal.

There are two different ways to save a message in the keyer terminal. You can type a message manually or load the message that you have saved in a text file. To save a message, type `~>#` where # is the message number followed by the content of the message. Begin typing in your message pressing the space bar between words. The keyer echoes each character as it is typed. Press the BACK SPACE key to delete the last character. At the end of your message, press ENTER to end your message. The keyer will respond by sending an end-of-message character (di-dah-di-dah-dit) and save your message. It will automatically insert “]” to the end of your message.

Alternately, type `~>#[message text]`. The keyer will end the message when the close square bracket “]” is received. When the open square bracket “[” is received, the keyer will use the close square bracket “]” (instead of the ENTER key) as the end-of-message indicator from that point on. This allows carriage returns, produced by the ENTER key, in the message.

To view the content of a message, type `~<#` where # is the message number. The memory will echo to the terminal.

### Message Commands

To	Types
Play Message #	<code>~#</code>
Save Message #	<code>~&gt;#[message text]</code> <code>~&gt;#message text ENTER</code>
View Message #	<code>~&lt;#</code>

Refer to “The Memory” section on page 35 for explanation of the MFJ-464’s message memory and how to use the embedded commands to enhance your message.

## Uploading and Downloading Messages:

To send messages either from your computer to the MFJ-464 or from the unit to your computer, you use a terminal program on the computer that is capable of transferring ASCII data. Configure the terminal software for 9600 baud, 8 data bits, no parity and one stop bit. Set the flow control to Xon/Xoff. To perform the transfer, you prepare either the computer or the Keyer to receive the file, and then send from the other.

### Loading a Memory Block from the Computer

- Type “~>#”, where # is a digit in the range of 1 to 4 for the message number. The word **RECEIVING** will appear. The unit now is ready to receive data from your computer.
- Begin sending the data from the computer, and a progress indicator will appear on line two of the display. Invalid data will be ignored during the loading process. To stop loading data at any time, press the Mode button.
- The MFJ-464 automatically inserts an open square bracket "[" at the beginning of every message. This is its "beginning-of-message" indicator. When you press Menu or ENTER to end a transfer, the unit inserts a close square bracket "]" as its "end-of-message" indicator. If you insert "]" at the end of your message file, the MFJ-464 will stop the transfer automatically when the close square bracket "]" is received. If the unit runs out of memory, the transfer will be stopped automatically.
- When the message transfer is completed, the unit will display **RECEIVED XXXX** where XXXX is a four-digit number indicating the number of characters received. This number includes the opening and ending message delimiters "[" and "]", plus any tabs and carriage returns.
- Press any button or paddle to return to normal operation.

**WARNING: Do not turn the power off while loading the memory; otherwise, the memory can be corrupted.**

One way of speeding data transfer is to configure your terminal program to strip out linefeeds that follow carriage returns. While computers store a carriage return as two characters (the carriage return followed by a linefeed), the MFJ-464 stores only the carriage return and generates the linefeed following it during playback. The additional linefeed thus does not need to be transferred to the Keyer.

### Sending Contents of a Memory Block to the Computer

- Configure your terminal program to receive ASCII data.
- Type “~<#”, where # is a digit in the range of 1 to 4 for the message. **SENDING XXXX** will appear on the display, where XXXX is a four-digit number indicating the number of characters in the message plus the message delimiters "[" and "]".
- A progress indicator will appear on the second line of the display to indicate the percentage of the message that has been sent.
- To stop the transfer at any time, press Mode or ESC.
- Return to normal operation when the transfer is completed.

# The Memory

## Message Memory

You may compose messages on a computer and load them into the MFJ-464's memory. The unit's memory system is quite flexible and allows up to four messages to be saved. One message can call another for additional flexibility. Using the memories, you may prepare the text for a classroom or over-the-air code practice session in advance. Also, a complete set of QSO exchange can be prepared and loaded into the MFJ-464. The memory is non-volatile, so it is saved even when the power is turned off and it does not require battery backup to preserve the recorded messages.

The unit's 1K memory is organized into four blocks of 256-bytes each, except the last block. This composes of four individual memory blocks arranged in a stack structure, illustrated in the diagram shown in Figure 9. The total memory available is 992 characters. Each memory block is nominally 256 characters, except the last block 4 that has a capacity of 224 characters. However, an individual message may fill more than one memory block. When this happens, blocks are filled sequentially, moving upward in the diagram. If a message begins in block 2 or higher memory blocks, 256 is reserved for each of the previous memory blocks.

For example, a message begun in block 2 will, if longer than 256 characters, flow into block 3 and then into block 4. However, it cannot flow downward into block 1. Because each of these lower memory blocks has 256 reserved, the message starting in block 2 can be a maximum of 736 characters.

Message playback will always start at the beginning of a message no matter which memory block of the message you have selected in the message menu.

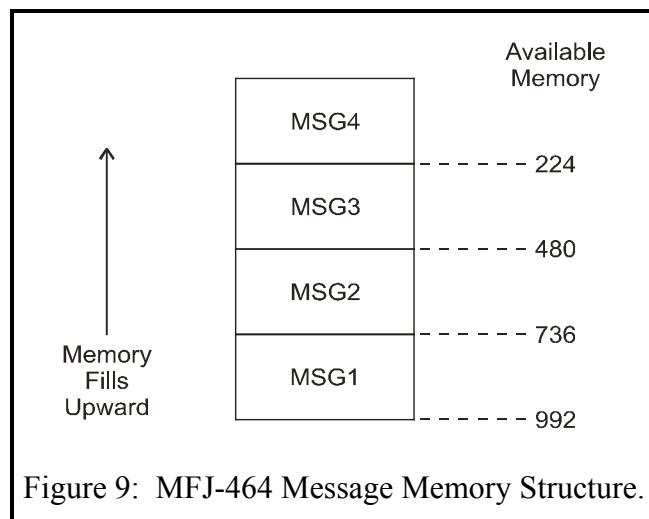

Figure 9: MFJ-464 Message Memory Structure.

## Preparing Messages

To prepare messages, use an ASCII text editor on your computer. Valid characters for messages include all those listed in the chart "Morse Code Character Set" on page 43, the space, tab and carriage return. In addition, there are special characters, shown in the table below. Any invalid characters in a message will be ignored when the file is downloaded.



### Special Characters

Characters	Represent
Square Brackets ( [ ] )	Delimiters for messages in memory.
Angle Brackets ( < > )	Delimiters for custom prosigns.
Back Slashes ( \ \ )	Delimiters for custom prosigns.
Space+Slash ( / )	Prefix for embedded commands.

**Note:** The Tab is displayed as a right arrow character and the Carriage Return is displayed as a left arrow character on the LCD. Both are sent as a word space.

You may control the unit's features during message playback by using embedded commands. These embedded commands can set sending speed, audio tone, and Farnsworth values, as well as provide great flexibility by allowing functions such as message looping and one message calling another. Embedded commands begin with a slash “/” and must enter as a separate word. Upper or lowercase letters may be used; embedded commands are not case-sensitive.

When a parameter such as Overall Speed or Tone is specified by an embedded command, the parameter will remain set during playback of that message. When playback of that message is completed or stopped, the value of the parameter will revert to the value set prior to the message playback.

**Note:** Adjusting the Speed control during message playback will undo the settings set by embedded commands /S, /U and /W.

### Embedded Commands

While in the message recording mode you may use embedded commands for special features. To use an embedded command, simply store the multi-character embedded command code within your message. To distinguish embedded commands from normal text, the embedded commands must be entered as a separate word; that is, it must be preceded by a word space (this leading space is ignored during playback). When encountered during message playback, the commands are executed. Note that if “/” is part of a single word, as in K5MFJ/4, it is sent as expected and is not executed as an embedded command. Embedded commands and their uses are explained below:

**/#** Call – calls message #, where # is a single digit in the range of 1 to 4. This allows one message to be called from another. When playback of the called message is finished, playback continues with the rest of the calling message. This command has a three-level deep stack; that is, a message can call another message, this message then calls another message, which in turn calls another message. One message should not call itself or any of its calling messages; otherwise, the stack will overflow resulting in infinite loop.

**Note:** The message stack size increases to seven levels deep if the message queue is disabled.

- /D**      **Decrement** – decrements the serial number. Serial number 0001 will decrement to 9999, skipping 0000 since it is not used. This feature allows a serial number to be sent twice in a message. For example: UR RST 559 559 SN /N /D SN /N.
- /F##**      **Farnsworth** – sets the current Farnsworth speed to ## WPM, where ## represents two digits in the range of 10 to 99. Setting ## to 00 disables the Farnsworth mode (two zeros must be used here).
- /FU#**      **Farnsworth Up** – increases the Farnsworth speed by # WPM, where # is a single digit in the range of 0 to 9. Increasing (wraparound) to 00 or less than or equal to the overall speed will disable the Farnsworth mode.
- /F+#**      **Farnsworth Down** – decreases the Farnsworth speed by # WPM, where # is a single digit in the range of 0 to 9. Decreasing to 00 or less than or equal to the overall speed will disable the Farnsworth mode.
- /FD#**      **Farnsworth Down** – decreases the Farnsworth speed by # WPM, where # is a single digit in the range of 0 to 9. Decreasing to 00 or less than or equal to the overall speed will disable the Farnsworth mode.
- /F-#**      **Farnsworth Down** – decreases the Farnsworth speed by # WPM, where # is a single digit in the range of 0 to 9. Decreasing to 00 or less than or equal to the overall speed will disable the Farnsworth mode.
- /G#**      **Gap** – inserts a gap of # standard intra-character spaces into the message, where # is a digit in the range of 1 to 9 (0 can be used but not practical). Invalid numeral code will automatically default to zero. This command is used to exaggerate inter-character and word spacing.
- /J#**      **Jump** – jumps to the message #, where # is a single digit in the range of 1 to 4. This allows you to continue your message into another message. This command can be used to create loop of multiple messages. Note that any character after “/J#” will not be sent.
- /L**      **Loop** – creates a loop of the *current* message block. Note that any character after “/L” will not be sent. For example: BEACON AA5CS 5 W /L.
- /N**      **Number** – inserts a contest serial number, in the range of 001 to 9999, into the message. Setup command Z controls the way zeroes and nines in the serial number are sent. Only three digits are sent for numbers less than 1000--use leading zeros when appropriate. The serial number is automatically post-incremented each time it is sent. The serial number increments from 0001 to 9999 and rolls over to 0001, skipping 0000 since it is not used. The serial number is set to the same one as before when power on. If a different serial number is desired, it must be re-programmed. The serial number can be set from 0000 to 9999 (0000 will automatically convert to 0001). For example: YOU ARE CONTACT NR /N.
- /P##**      **Pause** – inserts a timed pause of ## seconds into the message, where ## represents two digits in the range of 00 to 99. When setting pauses under 10 seconds, leading zero must be used. Pauses greater than 99 seconds are obtained by using consecutive commands that total the desired value. For example: TIMEOUT 1 SEC /P01 TIMEOUT 1 MIN /P60 TIMEOUT 1 MIN 39 SEC /P99 TIMEOUT 2 MIN /P60 /P60.
- /R**      **Repeat** – repeats playback from the beginning, even with calling messages. Note that any character after “/R” will not be sent.
- /S##**      **Speed** – sets the current overall speed to ## WPM, where ## represents two digits in the range of 05 to 99. When setting speeds under 10 WPM, leading zero must be used.

- /SU#**      **Speed Up** – increases the overall speed by # WPM, where # is a single digit in the range of 0 to 9.
- /S+#**
- /SD#**      **Speed Down** – decreases the overall speed by # WPM, where # is a single digit in the range of 0 to 9.
- /S-#**
- /T##**      **Tone** – sets the current sidetone frequency to approximately ##0 Hz, where ## represents two digits in the range of 30 to 99. Note that this command sets the sidetone to one of the 24 available frequencies.

##	Tone Freq.	##	Tone Freq.	##	Tone Freq.
30, 31, 32	305 Hz	54, 55, 56	549 Hz	78, 79, 80	793 Hz
33, 34, 35	335 Hz	57, 58, 59	579 Hz	81, 82, 83	823 Hz
36, 37, 38	366 Hz	60, 61, 62	610 Hz	84, 85, 86	854 Hz
39, 40, 41	396 Hz	63, 64, 65	640 Hz	87, 88, 89	884 Hz
42, 43, 44	427 Hz	66, 67, 68	671 Hz	90, 91, 92	915 Hz
45, 46, 47	457 Hz	69, 70, 71	701 Hz	93, 94, 95	945 Hz
48, 49, 50	488 Hz	72, 73, 74	732 Hz	96, 97, 98	976 Hz
51, 52, 53	518 Hz	75, 76, 77	762 Hz	99	1006 Hz

- /TU#**      **Tone Up** – increases the sidetone frequency by # available frequency, where # is a single digit in the range of 0 to 9.
- /T+#**
- /TD#**      **Tone Down** – decreases the sidetone frequency by # available frequency, where # is a single digit in the range of 0 to 9.
- /T-#**
- /U##**      **Ultra Speed** – sets the ultra speed mode for a message at speed of ##0 WPM, where ## represents two digits in the range of 10 to 99. For example, “10” is 100 WPM and “99” is 990 WPM. This command is used primarily for meteor scatter work. Note that Farnsworth, Weighting, Character Space, Word Space, Keying Compensation, and Tone settings are disabled during ultra speed message transmission. Also, messages using both regular speed and ultra speed can be created. To exit the ultra speed mode, set ## to 00 such as /U00 and the message will return to regular speed. Alternately, the message can be returned to a lower regular speed by use of the /S, /F, or /W command.
- /W##**      **Weight** – sets the code weight to ## percent, where ## represents two digits in the range of 25 to 75.
- /WU#**      **Weight Up** – increases the code weight by # percent, where # is a single digit in the range of 0 to 9.
- /W+#**
- /WD#**      **Weight Down** – decreases the code weight by # percent, where # is a single digit in the range of 0 to 9.
- /W-#**
- /X##**      **Xmit** – keys the keyer for ## seconds, where ## represents two digits in the range of 01 to 99. When setting time under 10 seconds, leading zero must be used. Time greater than 99 seconds is obtained by using consecutive commands that total the desired value. Set ## to 00 to key continuously for tuning the transmitter. For example: KEY 1 SEC /X01 KEY 1 MIN /X60 KEY 1 MIN 39 SEC /X99 KEY 2 MIN /X60 /X60 KEY INFINITE /X00.

## Appendices

### Resetting the Keyer

Each time the keyer is turned off, the microprocessor powers down and saves all memories and configurations to non-volatile memory ready to be used the next time the unit is turned on again. If the keyer is not working properly, even on initial power on, try resetting to the factory defaults.

### Factory Defaults

The unit is shipped with the following default settings:

- Main Menu                      Speed
- Setup Menu                    Overall Speed
- Quick Menu                    Keyboard Layout
  
- Overall Speed                 13 WPM
- Farnsworth                    off
- Weight                         50%
- Character Space              3 units
- Word Space                    7 units
- Keying Compensation         0 msec
- Keying Delay                 0 msec
- PTT Hang Time                1000 msec
- Tone Frequency               701 Hz
- Serial Number                0001
- Leading Zeroes               on and send as O (dah-dah-dah)
- Other Zeroes                 send as 0 (dah-dah-dah-dah-dah)
- Nines                         send as 9 (dah-dah-dah-dah-dit)
- Iambic Mode                  A
- Reverse Mode                 off (dot to tip, dash to ring)
- Paddle Mode                 automatic
- Monitor Mode                 on
- Output Mode                 on
- Queue Mode                  on
  
- Pulse Tune Speed             75 WPM
- Pulse Tune Weight            13% duty cycle
- Quick Speeds                 13, 15, 18 and 20 WPM
  
- Keyboard Layout              Qwerty keyboard
- Repeat Key                    off
- Caps Lock                     on

To reset the keyer to these defaults:

1. Turn off the power to the keyer.
2. Press and hold *both* the Mode and MSG2 buttons while turning the power on.
3. Release the buttons when **DEFAULTS RESET** appears on the display.
4. Resume with normal operation.

**WARNING:** If the MFJ-464 is behaving weird or acting erratic, try resetting the keyer to factory defaults.

### Message Memory Reset

To erase all message memories, hold down *both* the Mode and MSG4 buttons while turning the power on. A confirmation message **ERASE ALL MSGS?** will display. Press the **YES** button to clear all message memories, or press the **NO** button to cancel. Release the button to resume normal operation. Remember that all stored messages will be lost!

To erase a message, select that message for recording. Without typing or keying anything into memory, end the recording by typing ENTER or holding down any message button for two seconds. The keyer will respond with an end-of-message character (di-dah-di-dah-dit).

### Self Test

A self-test routine will check the functions of the MFJ-464. This routine checks the display, the paddles, the front-panel buttons, the internal memory and the audio circuitry. During the self-test, you may stop the test by turning off the unit; however, this should NOT be done during the memory test or the memory could be corrupted. The self-test can be completed in approximately 30 seconds.

Connections of the serial port and keyboard are not necessary for this test.

**Note:** *Performing the self-test will reset the unit to its factory default settings.*

Here is the self-test procedure:

1. Turn off the power to the keyer.
2. Connect a paddle to the Key Input jack.
3. Set volume to a comfortable listening level.
4. Press and hold *only* the Mode button while turning the power on.
5. The test begins by displaying a copyright message and firmware version number. This is the test of the display. This message is also sent to the serial port. Release the Mode button before the message completes.
6. You will be prompted to press the dot and dash paddles. This assumes the dot paddle is connected to the tip of the plug and the dash paddle to the ring of the plug. The LED should blink once for each press.
7. You will be prompted to press each of the front-panel buttons. The LED should blink once for each press.

8. Test the Set dial control by slowly turning it to the left 10 clicks and then slowly turning it to the right 10 clicks. Make sure not to turn the dial in the wrong direction. The LED should blink once at the 10<sup>th</sup> click on each direction.
9. The unit then tests its non-volatile memory. Notice this step will reset the unit to its factory default settings.
10. If the unit is okay, a repetitive message **PASS** will be displayed and sent as audio. If there is a problem, a failure message will be displayed and sent.
11. Once you have confirmed that the audio is okay, turn the unit off.

#### Failure Message Meanings:

- **DASH FAIL** Dash paddle (ring of the plug) is shorted or improperly connected.
- **DOT FAIL** Dot paddle (tip of the plug) is shorted or improperly connected.
- **MEMORY FAIL** Non-volatile memory circuitry is malfunction.
- **MODE FAIL** Mode button is shorted or improperly connected.
- **MSG1 FAIL** MSG1 button is shorted or improperly connected.
- **MSG2 FAIL** MSG2 button is shorted or improperly connected.
- **MSG3 FAIL** MSG3 button is shorted or improperly connected.
- **MSG4 FAIL** MSG4 button is shorted or improperly connected.
- **PD FAIL** Power down circuitry is malfunction.
- **SET FAIL** Set dial control is malfunction.

#### Power Down Circuit Test

This test checks the power down circuitry. It is recommended that this test should be done immediately after the regular self test described above.

***Note:** The keyer must be reset to factory defaults before performing this test.*

Here is the test procedure:

1. Make sure power to the keyer is off.
2. If the keyer has been reset to factory defaults, skip to step 7; otherwise continue with step 3.
3. Press and hold *both* the Mode and MSG2 buttons while turning the power on.
4. Release both buttons when **DEFAULTS RESET** appears on the display.
5. Make sure the display shows **513**.
6. Turn the power off.
7. Press and hold *only* the MSG2 button while turning the power on.
8. If the power down circuitry is okay, a repetitive message **PASS** will be displayed and sent as audio. If there is a problem, message **PD FAIL** will be displayed and sent as audio repetitively.
9. Turn the power off.

## Jumper Settings

The jumper settings come factory defaulted so that the RADIO SPKR jack is connected directly to the RADIO IN jack, and the transmitted sidetone is output to the SIDE TONE jack. An external speaker can be connected to the RADIO IN jack to monitor the received signal, since the receiver is connected to the RADIO IN jack. Another speaker can be connected to the SIDE TONE jack to monitor the transmitted sidetone.

To change these factory defaults you must remove the cover to the MFJ-494 and find the four jumpers located in the upper right-hand corner of the unit. Jumper JMP1 enables and disables the audio at the SIDE TONE jack. To hear both the transmitted sidetone and the received signal on the speakers connected to the RADIO SPKR jack, short either jumpers JMP2 and JMP4 or jumpers JMP3 and JMP5. Shorting jumpers JMP2 and JMP4 provides a higher sidetone level to the RADIO SPKR jack, whereas, shorting jumpers JMP3 and JMP5 provides a lower sidetone level to the RADIO SPKR jack.

## Troubleshooting

### **Q. Why can't I enable the Farnsworth mode?**

A. The overall speed is at its maximum of 99 WPM.

### **Q. Why do I get extra linefeeds when uploading to the computer?**

A. Configure your terminal program to strip the linefeeds from the carriage returns.

### **Q. The keyer is acting erratic?**

A. Reset the keyer to factory defaults setting by pressing both Mode and MSG2 buttons while turning the power on.

### **Q. How come I cannot increase the character spacing?**

A. The word spacing must be at least four units more than the character spacing.

## Technical Assistance

If you have any problem with this unit first check the appropriate section of this manual. If the manual does not reference your problem or your problem is not solved by reading the manual you may call *MFJ Technical Service* at **662-323-0549** or the *MFJ Factory* at **662-323-5869**. You will be best helped if you have your unit, manual and all information on your station handy so you can answer any questions the technicians may ask.

You can also send questions by mail to MFJ Enterprises, Inc., 300 Industrial Park Road, Starkville, MS 39759; by FAX to 662-323-6551; or by email to [techinfo@mfjenterprises.com](mailto:techinfo@mfjenterprises.com). Please include a complete description of the problem, an explanation of exactly how you are using the unit when the problem arises, and a complete description of any equipment you are using with this unit, such as a computer (including applicable software) or radio.

**Morse Code Character Set<sup>1</sup>**

A	di-dah	• –	N	dah-dit	– •
B	dah-di-di-dit	– • • •	O	dah-dah-dah	– – –
C	dah-di-dah-dit	– • – •	P	di-dah-dah-dit	• – – •
D	dah-di-dit	– • •	Q	dah-dah-di-dah	– – • –
E	dit	•	R	di-dah-dit	• – •
F	di-di-dah-dit	• • – •	S	di-di-dit	• • •
G	dah-dah-dit	– – •	T	dah	–
H	di-di-di-dit	• • • •	U	di-di-dah	• • –
I	di-dit	• •	V	di-di-di-dah	• • • –
J	di-dah-dah-dah	• – – –	W	di-dah-dah	• – –
K	dah-di-dah	– • –	X	dah-di-di-dah	– • • –
L	di-dah-di-dit	• – • •	Y	dah-di-dah-dah	– • – –
M	dah-dah	– –	Z	dah-dah-di-dit	– – • •
1	di-dah-dah-dah-dah	• – – – –	6	dah-di-di-di-dit	– • • • •
2	di-di-dah-dah-dah	• • – – –	7	dah-dah-di-di-dit	– – • • •
3	di-di-di-dah-dah	• • • – –	8	dah-dah-dah-di-dit	– – – • •
4	di-di-di-di-dah	• • • • –	9	dah-dah-dah-dah-dit	– – – – •
5	di-di-di-di-dit	• • • • •	0	dah-dah-dah-dah-dah	– – – – –
Period	[.]	di-dah-di-dah-di-dah	• – • – • –	AAA	
Comma	[,]	dah-dah-di-di-dah-dah	– – • • – –	---	
Question Mark or Request for Repetition	[?]	di-di-dah-dah-di-dit	• • – – • •	----	
Fraction Bar	[/]	dah-di-di-dah-dit	– • • – •	---	
End of Message or Cross	[+]	di-dah-di-dah-dit	• – • – •	---	
End of Work	[*]	di-di-di-dah-di-dah	• • • – • –	----	
Double Dash, Pause or Break	[=]	dah-di-di-di-dah	– • • • –	----	
Semicolon	[;]	dah-di-dah-di-dah-dit	– • – • – •	---	
Colon	[:]	dah-dah-dah-di-di-dit	– – – • • •	----	
Apostrophe	[']	di-dah-dah-dah-dah-dit	• – – – – •	---	
Quotation Mark	["]	di-dah-di-di-dah-dit	• – • • – •	---	
Hyphen or Dash	[-]	dah-di-di-di-di-dah	– • • • • –	----	
Underline	[_]	di-di-dah-dah-di-dah	• • – – • –	----	
Dollar Sign	[\$]	di-di-di-dah-di-di-dah	• • • – • • –	----	
Left Parenthesis	[ ( ]	dah-di-dah-dah-dit	– • – – •	----	
Right Parenthesis	[ ) ]	dah-di-dah-dah-di-dah	– • – – • –	----	
Wait	[&]	di-dah-di-di-dit	• – • • •	----	
Understood	[!]	di-di-di-dah-dit	• • • – •	----	
Starting Signal	[%]	dah-di-dah-di-dah	– • – • –	---	
Error	[@]	di-di-di-di-di-di-dit	• • • • • • • •	----	
Paragraph	[#]	di-dah-di-dah-di-dit	• – • – • •	----	
Invitation to Transmit		dah-di-dah	– • –	K	

1. FCC test requirement consists the 26 letters, the 10 numerals, the period, the comma, the question mark, —, —, — and —.



## Signals Used in Other Radio Services

Interrogatory	di-di-dah-di-dah	• • - • -	===
Emergency Silence	di-di-di-di-dah-dah	• • • • - -	====
Executive Follows	di-di-dah-di-di-dah	• • - • • -	---
Break-in Signal	dah-dah-dah-dah-dah	- - - - -	-----
Emergency Signal	di-di-di-dah-dah-dah-di-di-dit	• • • - - - • • •	===
Relay of Distress	dah-di-di-dah-di-di-dah-di-dit	- • • - • • - • •	---

## Some CW Abbreviations

73	Best regards	NR	Number; near
88	Love and kisses	NW	Now
ABT	About	OM	Old man
AGN	Again	OP	Operator
ANT	Antenna	R	Are; received; roger
BK	Back; break	RCVR	Receiver
CPY	Copy	RIG	Station equipment
CQ	Calling any station	RITE	Right
CUL	See you later	RST	Readability, strength, tone report
CU	See you	SIGS	Signals
DE	From	SKED	Schedule
DEG	Degree	STN	Station
DX	Distance; rare station	TEMP	Temperature
ES	And; "&"	TKS	Thanks
FB	Fine business; excellent	TNK	Thank
FER	For	TNX	Thanks
FREQ	Frequency	UR	Your; you're; you are
GA	Good afternoon	U	You
GE	Good evening	WL	Well; will
GM	Good morning	WTS	Watts
GN	Good night	WX	Weather
HR	Hear; here	XCVR	Transceiver
HW	How	XMTR	Transmitter
K	Go ahead	XYL	Wife (ex-young-lady)
MSG	Message	YL	Young lady

**Meaning of Q Signals**

QRA	The name of my station is
QRL	Do not interfere, Frequency busy
QRM	Being interfered with
QRN	Static
QRO	Increase power, High power
QRP	Decrease power, Low power
QRQ	Send faster
QRR	I am ready for automatic operation
QRS	Send more slowly
QRT	Stop sending
QRU	I have nothing for you
QRX	I will call again at ..., wait
QRZ	Who is calling me, I am
QSB	Your signal is fading
QSD	Your keying is defective
QSK	I can hear you between my signals
QSL	I am acknowledging receipt
QSU	Reply on this frequency or mode
QSX	I am listening to ... on ... kHz
QSY	Change frequency, change to xmit on ... kHz
QTH	My location (home) is
QTR	The correct time is
QTS	I will send so my frequency can be measured
QUB	Here is the info you requested
QUM	The distress traffic has ended

Send a "?" after a Q signal to ask for information or an action.

Example: QRZ: station (call) is ....      QRZ?: what is your station (call)?

## Setup Commands

Command	Via Menu	Via Keyboard	Via Terminal
Character Space	Char Space	~C# CTRL+C #	~C#
Decrement	Serial Number [MODE] + [MSG1]	~D CTRL+D F5	~D
Farnsworth	Farnsworth	~F## CTRL+F ##	~F##
Gap (Word Space)	Word Space	~G# CTRL+G #	~G#
Handkey	Paddle: Handkey	~H CTRL+H	~H
Iambic	Iambic	~I# CTRL+I #	~I#
PTT Hang Time	PTT Hang Time	~J##### CTRL+J #####	~J#####
Keying Compensation	Key Compensation	~K## CTRL+K ##	~K##
Lag (Keying Delay)	Key Delay	~L## CTRL+L ##	~L##
Monitor	Monitor	~M# CTRL+M #	~M#
Number	Serial Number	~N##### CTRL+N #####	~N#####
Output	Output	~O# CTRL+O #	~O#
Paddle	Paddle	~P# CTRL+P #	~P#
Queue	Queue	~Q# CTRL+Q #	~Q#
Speed	Overall Speed	~S## CTRL+S ## CTRL+UP CTRL+DOWN CTRL+LEFT CTRL+RIGHT	~S##
Tone	Tone	~T## CTRL+T ## SHIFT+UP SHIFT+DOWN SHIFT+LEFT SHIFT+RIGHT	~T##
reVerse	Reverse	~V CTRL+V	~V
Weight	Weight	~W## CTRL+W ## ALT+UP ALT+DOWN ALT+LEFT ALT+RIGHT	~W##
Xmit (carrier tune)	[MODE] + [DAH]	~X CTRL+X	~X
pulse tune	[MODE] + [DIT]	~Y CTRL+Y	~Y
Zeroes and nines	Leading Zeroes Other Zeroes Nines	~Z### CTRL+Z ###	~Z###

Note: Terminal commands can be used via the keyboard, but not vice versa.

Schematics

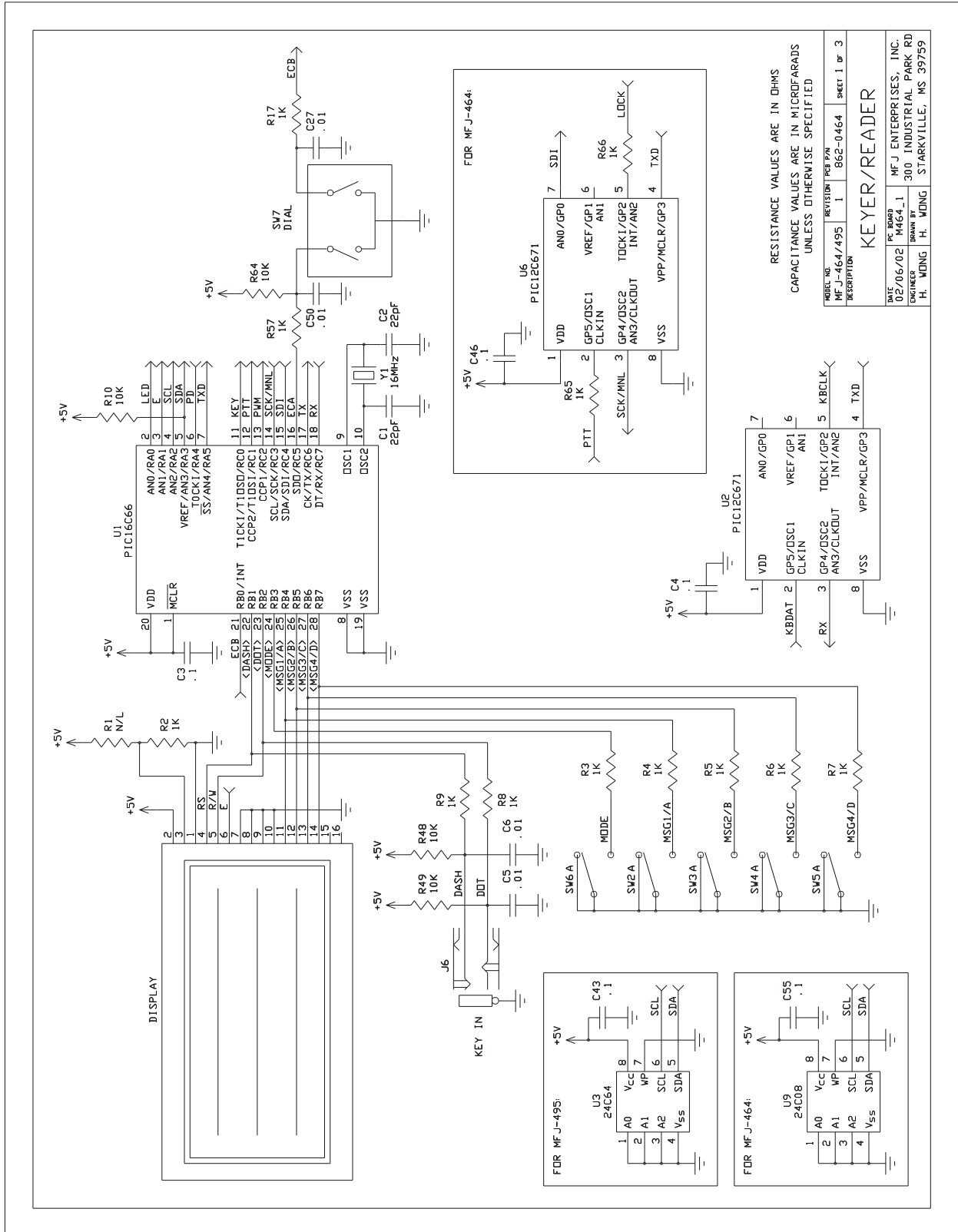

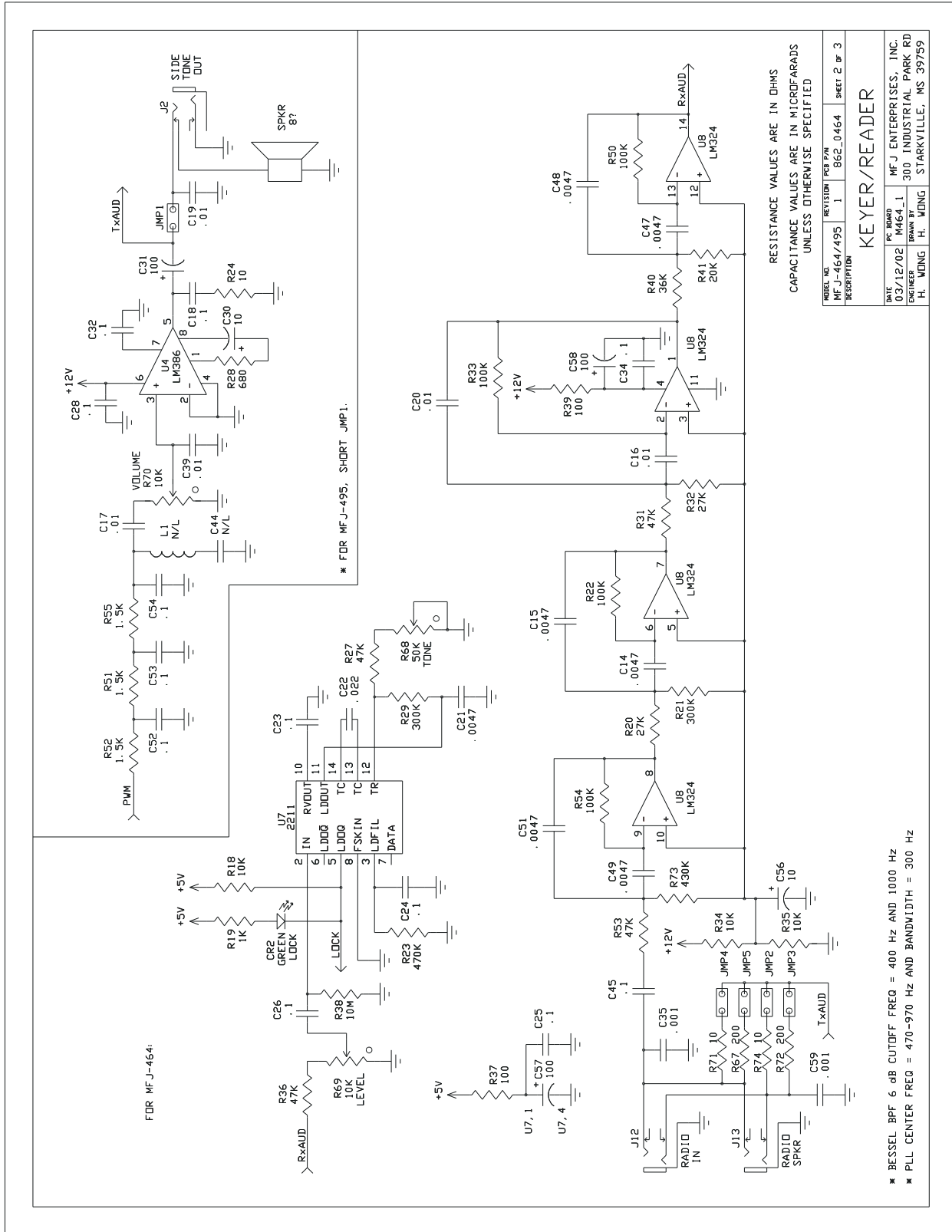

RESISTANCE VALUES ARE IN OHMS  
CAPACITANCE VALUES ARE IN MICROFARADS  
UNLESS OTHERWISE SPECIFIED

MODEL NO.	REVISION	PART NO.
MFJ-464/495	1	862_0464
DESCRIPTION		SHEET 2 OF 3

KEYER/READER	
DATE	PC BOARD
03/12/02	MFJ-464-1
DESIGNED BY	MANUFACTURED BY
H. WONG	H. WONG
MFJ ENTERPRISES, INC. 300 INDUSTRIAL PARK RD STARKVILLE, MS 39759	

